



NORTH ROOM
201-210

PORTE TAGLIAFUOCO IN ACCIAIO
STEEL FIRE DOORS

NEW IDRA

El₂ 60/120

THE ITALIAN STYLE DOOR

Dierre

YOUR HOME, YOUR LIFE

7	PORTA PER ESTERNI MARCATA "CE" SECONDO EN 16034 <i>"CE" MARKED EXTERNAL DOOR FOLLOWING EN 16034</i>
9	PORTA PER INTERNI OMOLOGATA TAGLIAFUOCO <i>INTERNAL FIRE-RATED DOOR</i>
11	NEW IDRA
14	PERFORMANCE E CARATTERISTICHE TECNICHE, IN DETTAGLIO <i>PERFORMANCE AND SPECIFICATIONS, IN DETAIL</i>
18	OPTIONAL
19	SOLUZIONI DI FISSAGGIO <i>FITTING SOLUTIONS</i>
20	INGOMBRI IN APERTURA <i>OPENING OVERALL DIMENSIONS</i>
24	LE FINESTRATURE <i>THE GLAZING</i>
25	SOPRALUCE E FIANCHILUCE <i>FANLIGHTS AND SIDE LIGHTS</i>
26	FINITURE MANIGLIONI NO PANIC <i>HANDLES NO PANIC FINISH</i>
27	SCHEDE TECNICHE <i>TECHNICAL SHEETS</i>
46	TAVOLA SINOTTICA <i>SYNOPTIC TABLE</i>



New Idra E₂ 60 un battente in acciaio inox
New Idra E₂ 60 stainless steel single leaf





New Idra E1, 120 un battente laccato grigio
New Idra E1, 120 single leaf lacquered gray



New Idra EI₂ 120 doppio battente laccato RAL 3020
New Idra EI₂ 120 double leaf lacquered RAL 3020



DICHIARAZIONE DI PRESTAZIONE n.20200P000000000002908-01#00000644769

- Codice di Identificazione unico del prodotto - tipo:
NEW IDRA 120 anta singola
- Usi previsti, conformemente alla relativa specifica tecnica armonizzata, come previsto dal fabbricante:
PORTE ESTERNE DI COMUNICAZIONE IN LUOGHI RESIDENZIALI E COMMERCIALI
- Nome, denominazione commerciale registrata o marchio registrato e indirizzo del fabbricante:
TREDI, Strada della Varletta, 21, 14019 Villanova d'Asti (AT), Italia
- Sistema di valutazione e verifica della costanza della prestazione (sistema VVCP):
Sistema 3
- Norma armonizzata:
EN 14351-1:2006+A2:2016 Finestre e Porte - Norma di Prodotto, Caratteristiche Prestazionali - Parte 1: Porte Pedonali
- Organismo notificato:
0407 - ISTITUTO GIORDANO
- Prestazioni Dichiarate:

Caratteristiche Essenziali		valore	Prestazione
Altezza LNI	descrizione	2313	NPD
Capacità portante dei dispositivi di sicurezza	descrizione	non applicabile	
Capacità di sblocco	descrizione	19 (1:1-1)	1
Permeabilità all'aria	descrizione	55%	
Assorbimento acustico	descrizione	75%	
Proprietà radiative - fattore solare	descrizione		NPD
Proprietà radiative - trasmittanza luminosa	descrizione		NPD
Resistenza all'urto	descrizione		NPD
Resistenza al carico del vento - pressione di prova	descrizione	come richiesto	
Resistenza al carico del vento - flessione totale	descrizione		NPD
Sostanze pericolose	descrizione		NPD
Tenuta all'acqua - non schermata (Metodo 1)	descrizione		
Tenuta all'acqua - schermata (B)	descrizione	W(m ² x K)	
Trasmittanza termica	descrizione		

Nota: NPD: no performance determined (nessuna prestazione determinata)
 Nota 1: Il campione è stato sottoposto a prova secondo metodo A (serramento) che simula le condizioni di un serramento dotato di protezioni, è da considerare che il prodotto sopra identificato è conforme all'insieme delle prestazioni dichiarate. La presente dichiarazione di responsabilità viene emessa, in conformità al regolamento (UE) n.305/2011, sotto la sola responsabilità del fabbricante sopra identificato.

Firmato a nome e per conto del Fabbricante da:
 Alessandro De Robertis
 Luogo e Data del rilascio



DICHIARAZIONE DI PRESTAZIONE n.20200P000000000002908-06#00000644769

- Codice di Identificazione unico del prodotto - tipo:
NEW IDRA 120 anta singola
- Usi previsti, conformemente alla relativa specifica tecnica armonizzata, come previsto dal fabbricante:
COMPARTIMENTAZIONE AL FUOCO E/O AL FUMO E/O SU VIE DI FUGA
- Nome, denominazione commerciale registrata o marchio registrato e indirizzo del fabbricante:
TREDI, Strada della Varletta, 21, 14019 Villanova d'Asti (AT), Italia
- Sistema di valutazione e verifica della costanza della prestazione (sistema VVCP):
Sistema 1
- Norma armonizzata:
EN 16034:2014 Porte Pedonali, Porte Industriali, Commerciali, da Garage e Finestre Aperte - Norma di Prodotto, Caratteristiche Prestazionali - Caratteristiche di Resistenza al Fuoco e/o Controllo del Fumo
- Organismo notificato:
0474 - RINA
- Prestazioni Dichiarate:

Caratteristiche Essenziali		valore	Prestazione	Norma armonizzata
Autochiusura	descrizione		NPD	vedi punto 5
Capacità di rilascio	descrizione		NPD	
Durabilità dell'autochiusura	descrizione		NPD	
Durabilità della capacità di rilascio	descrizione		NPD	
Resistenza al fuoco	descrizione		NPD	
Tenuta al fumo	descrizione		Ely 120	
	descrizione		Sa	

Nota: NPD: no performance determined (nessuna prestazione determinata)
 La prestazione del prodotto sopra identificato è conforme all'insieme delle prestazioni dichiarate.
 La presente dichiarazione di responsabilità viene emessa, in conformità al regolamento (UE) n.305/2011, sotto la sola responsabilità del fabbricante sopra identificato.

Firmato a nome e per conto del Fabbricante da:
 Alessandro De Robertis Amministratore Delegato
 Luogo e Data del rilascio

TREDI-GRUPPO DIERRE-ANNO 2020
 0474-RINA
 0474-CPR-2051
 CE
 NEW IDRA 120
 N. 00001077



PORTA PER ESTERNI MARCATA “CE” SECONDO EN 16034

La porta a battente **New Idra** può essere marcata **CE** secondo le norme di prodotto **EN 14351-1** e **EN 16034**. Per poter ottenere tali marcature è necessario sottoporre il processo produttivo ed il prodotto stesso a specifici iter e controlli che garantiscano il fatto che tutta la fase produttiva avvenga nelle modalità e con i componenti descritti nei vari documenti di prova.

La norma di prodotto EN 16034 dal titolo "Porte pedonali, porte industriali, commerciali, da garage e finestre apribili - Norma di prodotto, caratteristiche prestazionali - Caratteristiche di resistenza al fuoco e/o controllo del fumo" rappresenta un caso anomalo di quanto finora esistente a livello prodotti da costruzione, è infatti una norma che prevede la marcatura CE come scopo ma che non può vivere di vita propria. Per essere più chiari, questa norma non può essere applicata ad un prodotto se questo non è già marcato CE a seguito applicazione della norma di prodotto specifica del prodotto stesso. Quindi si può dire che la EN 16034 è una norma che porta ad una marcatura "secondaria" che deve obbligatoriamente viaggiare in parallelo con una marcatura "principale".

La norma di prodotto per la marcatura "principale" attualmente in vigore per le porte New Idra è la: EN 14351-1 dal titolo "Finestre e porte - Norma di prodotto, caratteristiche prestazionali - Parte 1: Finestre e porte esterne pedonali". Manca all'appello una norma "principale" molto importante che è la EN 14351-2 dal titolo "Finestre e porte - Norma di prodotto, caratteristiche prestazionali - Parte 2: Finestre e porte interne pedonali". La mancanza di questa norma genera non poca confusione sul mercato per quanto riguarda le porte a battente. Infatti le porte interne allo stato attuale non possono essere marcate CE secondo la EN 16034 (marcatura secondaria) in quanto non può essere applicata una marcatura "principale".

Alla marcatura CE secondo la EN 16034 per prodotti tagliafuoco sono legate tutta una serie di norme definite EXAP che permettono estensioni di vario genere sul prodotto a fronte di prove al fuoco effettuate secondo la EN 1634-1. La marcatura CE su questo tipo di prodotti è obbligatoria dal 1/11/19, da tale data è quindi obbligatorio fornire l'unico documento che accompagna la marcatura: la DoP (dichiarazione di prestazioni). Sul prodotto deve essere apposta un'etichetta che renda rintracciabile il prodotto, non è obbligatoria la targhetta metallica che però viene comunque applicata sul prodotto per garantire un'identificazione nel tempo.

Il prodotto New Idra è classificato da **El:60** a **El:120** nelle varie configurazioni presenti a listino e a catalogo, per maggiori dettagli rivolgetevi ad un rivenditore ufficiale Dierre.

“CE” MARKED EXTERNAL DOOR FOLLOWING EN 16034

The New Idra hinged door can be CE marked according to EN 14351-1 and EN 16034 product standards. In order to obtain these markings, it is necessary for the production process and the product itself to undergo specific processes and checks that ensure the whole production phase takes place following the methods and with the components described in the various test documents.

The EN 16034 product standard named "Pedestrian doorsets, industrial, commercial, garage doors and openable windows - Product standard, performance characteristics - Fire resisting and/or smoke control characteristics" represents an odd case regarding existing regulations concerning building products, it is in fact a standard foreseeing for CE marking as a purpose but that cannot stand alone.

To be clearer, this standard cannot be applied to a product if it is not already CE-marked as a result of the product-specific product standard. So it can be said that EN 16034 standard is a standard that leads to a "secondary" marking that must necessarily go together with a "main" marking. The currently in force product standard for the "main" marking for New Idra doors is: EN 14351-1 named "Windows and doors - Product standard, performance characteristics - Part 1: Windows and external pedestrian doorsets". There is no relevant "main" standard that is EN 14351-2 named "Windows and doors - Product standard, performance characteristics - Part 2: Internal pedestrian doorsets". The lack of this standard generates a lot of confusion on the market with regard to swing doors. In fact, internal doors cannot currently be CE marked according to EN 16034 (secondary marking) because a "main" marking cannot be applied.

The CE marking according to EN 16034 for fire-rated products is linked to a whole series of rules defined as EXAP that allow various kinds of extensions on the product having fire tests carried out according to EN 1634-1.

*The CE marking on this type of product has been mandatory since 1/11/19, so from that date it is mandatory to provide the only document that accompanies the marking: the DoP (declaration of performance). A label must be placed on the product to make it traceable, the metal tag is not mandatory, but it is still applied on the product to ensure identification over time. The New Idra product is classified from **El:60** to **El:120** in the various configurations on the price list and in the catalogue, for more details please contact a Dierre official retailer.*

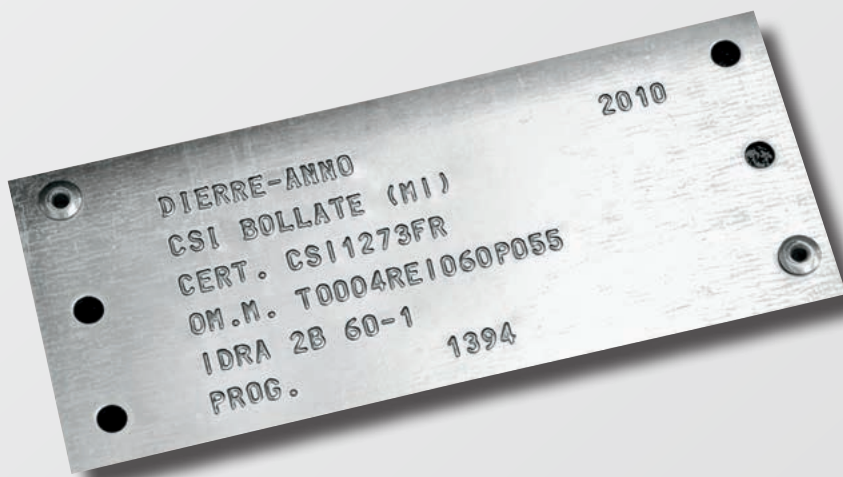
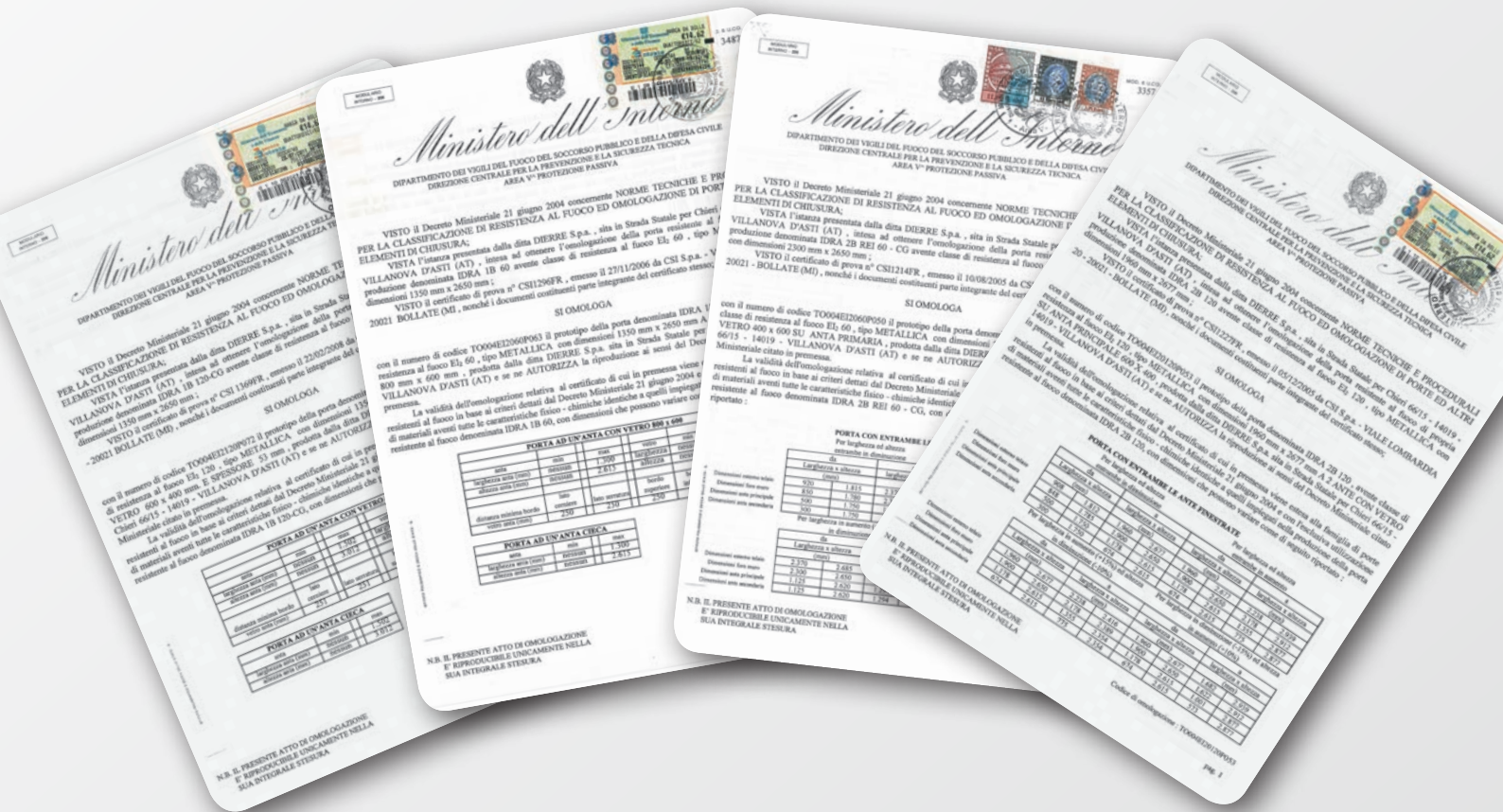

PORTA PER INTERNI OMOLOGATA TAGLIAFUOCO

New Idra è certificata e omologata per la resistenza al fuoco secondo la norma europea EN 1634-1, rilasciata in seguito a test specifici che garantiscono la conformità ai rigorosi standard.

Classificazione EI. Il termine "EI" sigla la capacità di un prodotto di conservare, di fronte all'attacco del fuoco, alcune caratteristiche per un tempo stabilito. Ogni lettera si riferisce a una diversa caratteristica.

La E indica la tenuta, quindi non produrre né lasciare passare fumo e fiamme. La I sta per isolamento termico, cioè la capacità di ridurre la trasmissione del calore. Di conseguenza, si definisce "E" una porta che conserva la propria stabilità ed è in grado di bloccare le fiamme e "EI" un prodotto che, oltre alle qualità precedenti, limita la trasmissione del calore fino a un massimo di 180°C sul lato non a contatto diretto con il fuoco (ovvero lato freddo).

Per ogni prodotto e accessorio, la validità della classificazione nei diversi paesi europei è soggetta a verifica presso l'ufficio tecnico Dierre.

INTERNAL FIRE-RATED DOOR

New Idra is certified and approved for fire resistance according to the European EN 1634-1 standard, issued following specific tests that ensure compliance to strict standards.

EI Classification. *The term "EI" means the ability of a product to preserve, in the event of fire attack, certain characteristics for a set time. Each letter refers to a different characteristic. E indicates the seal, so not producing or letting smoke and flames pass through. I stands for thermal insulation, that is, the ability to reduce heat transmission. As a result, "E" is a door that maintains its stability and is able to block flames and "EI" is a product that, in addition to the previous features, limits the transmission of heat up to a maximum of 180 degrees C on the side not in direct contact with the fire (i.e. cold side). For each product and accessory, the validity of the classification in the different European countries is subject to the Dierre technical office verification..*

NEW IDRA

New Idra è una porta tagliafuoco flessibile e sicura, che risponde alle esigenze di compartimentazione di abitazioni, supermercati, ospedali, magazzini, locali macchine, cinema, ristoranti e qualsiasi altro edificio pubblico. Idonea a varchi di medie dimensioni tipiche di porte a 1 e 2 battenti, New Idra combina in un giusto equilibrio differenti caratteristiche, che la rendono una delle chiusure tagliafuoco più diffuse. Grazie alla facilità di posa, senza forature aggiuntive o scantonature nel muro, si adatta ad ogni spazio con estrema versatilità. La complanarità al profilo del telaio, le zanche prestampate nel telaio stesso e la chiusura con 3 cerniere garantiscono massima funzionalità. Inoltre, è disponibile in una vasta gamma di colori e dimensioni, sia standard che fuori misura, in versione cieca, con la robustezza tipica dell'acciaio, e nella versione vetrata, con differenti opzioni di finestrature. New Idra è disponibile anche in versione antipanico o con maniglia/maniglia e protezione superficiale, con pellicola da asportare dopo la posa.

New Idra is a flexible and safe fire door, that meets the protection needs of houses, supermarkets, hospitals, warehouses, machine rooms, theatres, restaurants and any other public building. Suitable for medium size openings, typical of single or double leaf doors, New Idra is the ideal balance of different features, that make it one of the most popular fire doors. They can be installed easily, without additional drilling or alterations to the wall structure, with great versatility suits any environment. The profile flush to the frame, the ties embedded in the frame, and a 3-hinge closure guarantee the highest performances.

We also offer a wide range of colours and sizes, both standard and special sizes; in the blank version, with the typical sturdiness of steel, and in the glazed version, with different glazing options available. New Idra is also available in the panic exit version or with handle/handle and surface protection, with a film that can be removed after fitting.





New Idra EI, 120 doppio battente laccato RAL 7037
New Idra EI, 120 double leaf lacquered RAL 7037

PERFORMANCE E CARATTERISTICHE TECNICHE, IN DETTAGLIO

PERFORMANCE AND SPECIFICATIONS, IN DETAIL

Struttura del telaio
rigida con zanche
*Rigid frame
structure with ties*

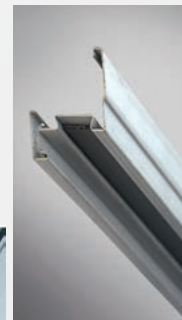

Complanarità tra telaio e anta
Complanarity between frame and leaf



I battenti e i telai sono di serie zincati con la finitura avorio chiaro. Opzionalmente sono disponibili le finiture RAL per esterni o in acciaio inox.
Standard leaves and frames are zinc-coated and come in light ivory finishing. RAL exterior or stainless steel finishings are available upon request.

Di serie le porte New Idra sono fornite con la serratura antincendio, inserto patent con chiavi in dotazione e coppia di maniglie antinfortunistiche in resina nera. Opzionalmente si possono abbinare alla porta maniglioni antipanico, maniglieria in acciaio inox, cilindri cifrati, serrature a 3 punti di chiusura.
New Idra doors come with the following standard features: fire-resistant lock, Patent insert complete with keys and two accident-prevention handles in black epoxy. Stainless steel handles, encrypted cylinders, 3-lock points locks can be combined to the panic exit bars.

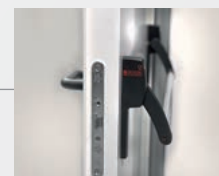

Per il controllo accessi è possibile montare lo sblocco elettrico.
Electric unlock can be mounted for access monitoring.

All'interno delle ante, sul lato a spingere, viene montato sempre un rinforzo, per migliorare la struttura della porta in caso del montaggio del maniglione anche in un secondo tempo.
A reinforcement is always fitted inside the leaves, on the push side, in order to improve the door structure in case a panic exit bar is fitted or retro-fitted.

Soglia mobile.
Mobile threshold.





Tutte le porte tagliafuoco, di serie, sono dotate di un sistema di autochiusura. Per migliorare l'uso della porta si può dotare la porta di chiudiporta, che possono essere con braccio a V, a slitta, o incassati nell'anta.

All fire doors come with a standard self-closure system. In order to improve ease of use, the door can be equipped with V-boom, sliding or leaf-enclosed door closers.



All'interno delle ante, sul lato a tirare, viene montato sempre un rinforzo, per migliorare la struttura della porta in caso del montaggio del chiudiporta anche in un secondo tempo.

A reinforcement is always fitted inside the doors, on the pull-side, in order to improve the structure of the door in case of a door closer is fitted or retro-fitted.

Le porte New Idra possono essere corredate di finestrate ad oblò o rettangolari, di varie misure. Inoltre, su richiesta del cliente, è possibile spostarle dalla posizione standard.

New Idra doors can be fitted with round or square glazing, in several sizes. They can also be moved from their standard position upon request.



Le porte New Idra EI₆₀ possono essere dotate di griglie d'aerazione di varie misure.

New Idra doors EI₆₀ can be fitted ventilation grilles in several sizes.



Le cerniere in dotazione alle porte tagliafuoco permettono una regolazione, anche a posteriori, della anta per compensare le imperfezioni murarie e d'installazione.

The hinges provided with the fire doors also allow to perform a future set-up of the door to compensate possible wall and installation imperfections.

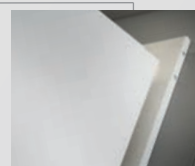

PERFORMANCE E CARATTERISTICHE TECNICHE, IN DETTAGLIO

PERFORMANCE AND SPECIFICATIONS, IN DETAIL

Struttura del telaio
rigida con zanche
*Rigid frame
structure with ties*



I battenti e i telai sono di serie zincati con la finitura
avorio chiaro. Opzionalmente sono disponibili le
finiture RAL per esterni o in acciaio inox.
*Standard leaves and frames are zinc-coated and come
in light ivory finishing. RAL exterior or stainless steel
finishings are available upon request.*

Complanarità tra telaio e anta
*Complanarity between
frame and leaf*



2

Di serie le porte New Idra sono fornite con la serratura antincendio,
inserto patent con chiavi in dotazione e coppia di maniglie
antifortunistiche in resina nera. Opzionalmente si possono abbinare
alla porta maniglioni antipanico, maniglia in acciaio inox, cilindri
cifrati, serrature a 3 punti di chiusura.
*New Idra doors come with the following standard features:
fire-resistant lock, Patent insert complete with keys and two
accident-prevention handles in black epoxy. Stainless steel handles,
encrypted cylinders, 3-lock points locks can
be combined to the panic exit bars.*

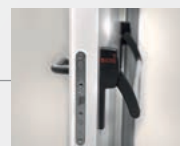

Per il controllo accessi è possibile montare lo sblocco elettrico.
Electric unlock can be mounted for access monitoring.

All'interno delle ante, sul lato a spingere, viene
montato sempre un rinforzo, per migliorare la
struttura della porta in caso del montaggio del
maniglione anche in un secondo tempo.
*A reinforcement is always fitted inside the
leaves, on the push side, in order to improve
the door structure in case a panic exit
bar is fitted or retro-fitted.*

Soglia mobile.
Mobile threshold.

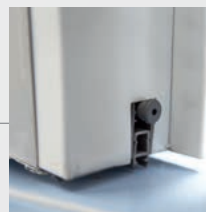

Selettore di chiusura
Closure selector



Tutte le porte tagliafuoco, di serie, sono dotate di un sistema di autochiusura. Per migliorare l'uso della porta si può dotare la porta di chiudiporta, che possono essere con braccio a V o a slitta.

All fire doors come with a standard self-closure system. In order to improve ease of use, the door can be equipped with V-boom, sliding or leaf-enclosed door closers.



All'interno delle ante, sul lato a tirare, viene montato sempre un rinforzo, per migliorare la struttura della porta in caso del montaggio del chiudiporta anche in un secondo tempo.

A reinforcement is always fitted inside the doors, on the pull-side, in order to improve the structure of the door in case of a door closer is fitted or retro-fitted.

Le porte New Idra possono essere corredate di finestrate ad oblò o rettangolari, di varie misure. Inoltre, su richiesta del cliente, è possibile spostarle dalla posizione standard.

New Idra doors can be fitted with round or square glazing, in several sizes.

They can also be moved from their standard position upon request.



Le porte New Idra EI₂ 60 possono essere dotate di griglie d'aerazione di varie misure.

New Idra doors EI₂ 60 can be fitted ventilation grilles in several sizes.

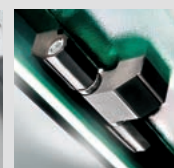
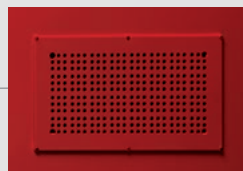

Le cerniere in dotazione alle porte tagliafuoco permettono una regolazione, anche a posteriori, della anta per compensare le imperfezioni murarie e d'installazione.

The hinges provided with the fire doors also allow to perform a future set-up of the door to compensate possible wall and installation imperfections.



EXTRA PIÙ COMUNI

POPULAR EXTRAS

EXTRA IN BASE ALLA TIPOLOGIA DI MURATURA

Installazione con zanche a murare (di serie)
Installazione con tasselli
Installazione con controtelaio
Installazione su mazzetta
Installazione su pareti
in cartongesso EI₂ 60 e EI₂ 120

EXTRA PER ESIGENZE DI SICUREZZA

Porte per uscite antipanico
Porte per uscite d'emergenza
Porte a 3 punti di chiusura
Porte normalmente aperte

EXTRA PER ESIGENZE D'IMPIEGO

Finestratura
Chiudiporta
Fascioni/zoccoli paracolpi
Imbotti
Porte con sopra luce e fiancoluci
Porte in acciaio inox

EXTRA PER CONTROLLO ACCESSI

Sblocco elettrico
Serrature elettriche
Elettromaniglia
Elettroblocco magnetico

EXTRA PER ESIGENZE ESTETICHE

Personalizzazione delle porte grazie
all'ampia gamma di finiture RAL

EXTRA PER ELEVATE ESIGENZE PRESTAZIONALI

Abbattimenti acustici
Tenuta aria/vento
Antieffrazione

EXTRAS BASED ON THE WALL TYPE

*Installation with wall ties (standard)
Installation with bolts
Installation with subframe
Installation on reveal
Plasterboard wall installation
EI₂ 60 and EI₂ 120*

EXTRAS FOR SAFETY REQUIREMENTS

*Panic exit doors
Emergency exit doors
3-lock points doors
Normally open doors*

EXTRAS FOR USAGE REQUIREMENTS

*Grazing
Door closer
Bumper bands/skirting
Cornices
Doors with fanlights and side lights
Stainless steel doors*

ACCESS CONTROL EXTRAS

*Electric release
Electric locks
Electrohandle
Magnetic electric block*

AESTHETIC EXTRAS

*Door customisation thanks to the
wide range of RAL finishings*

EXTRAS FOR HIGH-PERFORMANCE NEEDS

*Noise reduction
Air/wind tightness
Burglar resistance*

SOLUZIONI DI FISSAGGIO

FITTING SOLUTIONS

TELAIO A MURARE
BRICK-IN FRAME

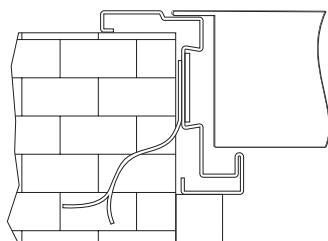

TELAIO SU CONTROTELAIO
FRAME ON SUBFRAME

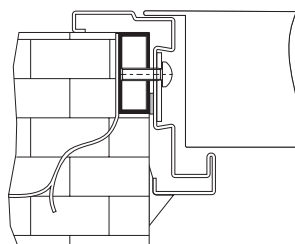

TELAIO SU CONTROTELAIO
(solo PORTA FIREWALL)
FRAME ON SUBFRAME
(FIREWALL ONLY)

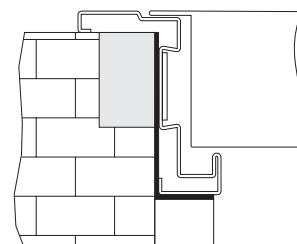

TELAIO A TASSELLARE
BOLT-IN FRAME

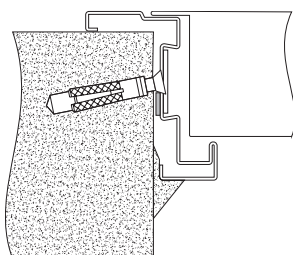

TELAIO SU MAZZETTA
Tipo VISUAL CON PROFILO A "L"
FRAME ON REVEAL
VISUAL TYPE WITH "L" SHAPED PROFILE

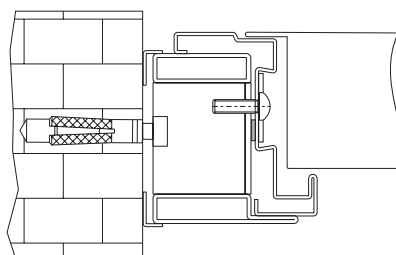

TELAIO SU MAZZETTA
Tipo VISUAL CON PROFILO A "T"
FRAME ON REVEAL
VISUAL TYPE WITH "T" SHAPED PROFILE

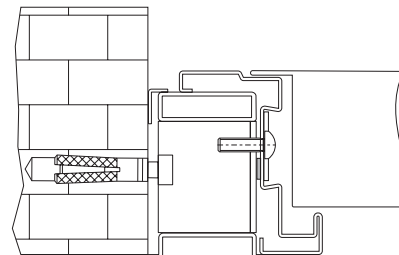

MONTAGGIO SU
PARETE IN CARTONGESSO EI₂ 60
EI₂ 60 PLASTERBOARD
WALL MOUNT

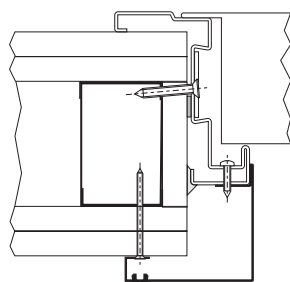

L'imbotte non è necessario
con la marcatura CE
The padding is not necessary
with the CE marking

MONTAGGIO SU
PARETE IN CARTONGESSO EI₂ 120
EI₂ 120 PLASTERBOARD
WALL MOUNT

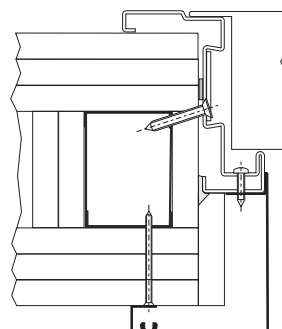

L'imbotte non è necessario
con la marcatura CE
The padding is not necessary
with the CE marking

INGOMBRI IN APERTURA

OPENING OVERALL DIMENSIONS

NEW IDRA 1 BATTENTE EI₂ 60/120
 NEW IDRA SINGLE LEAF EI₂ 60/120

INGOMBRI PORTA CON APERTURA A 90°
 OPENING OVERALL DIMENSIONS WITH A 90° OPENING ANGLE

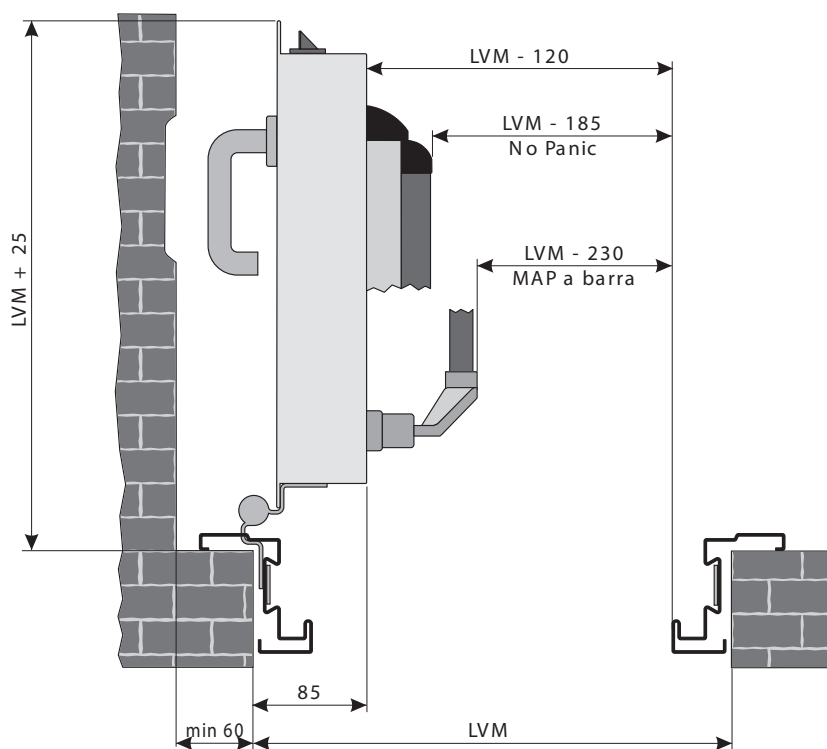

INGOMBRI PORTA CON APERTURA A 180°
 OPENING OVERALL DIMENSIONS WITH A 180° OPENING ANGLE

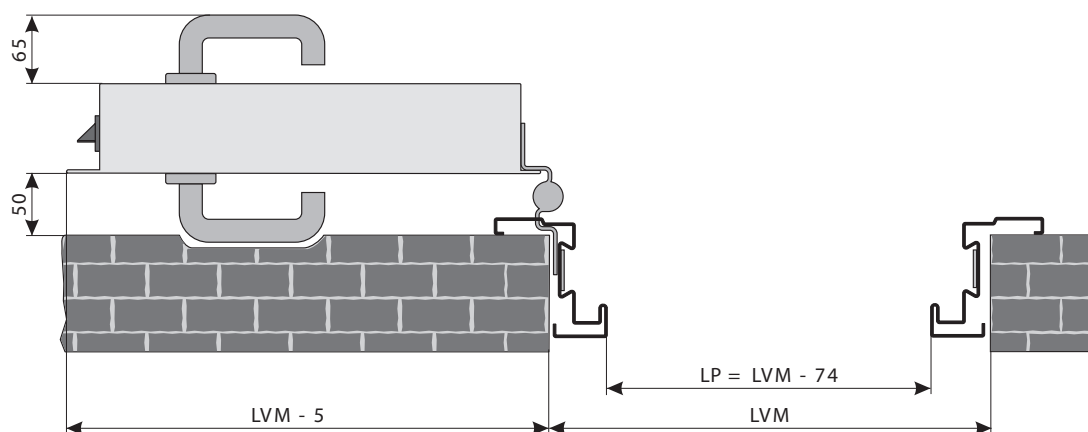

NEW IDRA 2 BATTENTI EI₂ 60/120
 NEW IDRA DOUBLE LEAF EI₂ 60/120

INGOMBRI PORTA CON APERTURA A 90°
 OPENING OVERALL DIMENSIONS WITH A 90° OPENING ANGLE

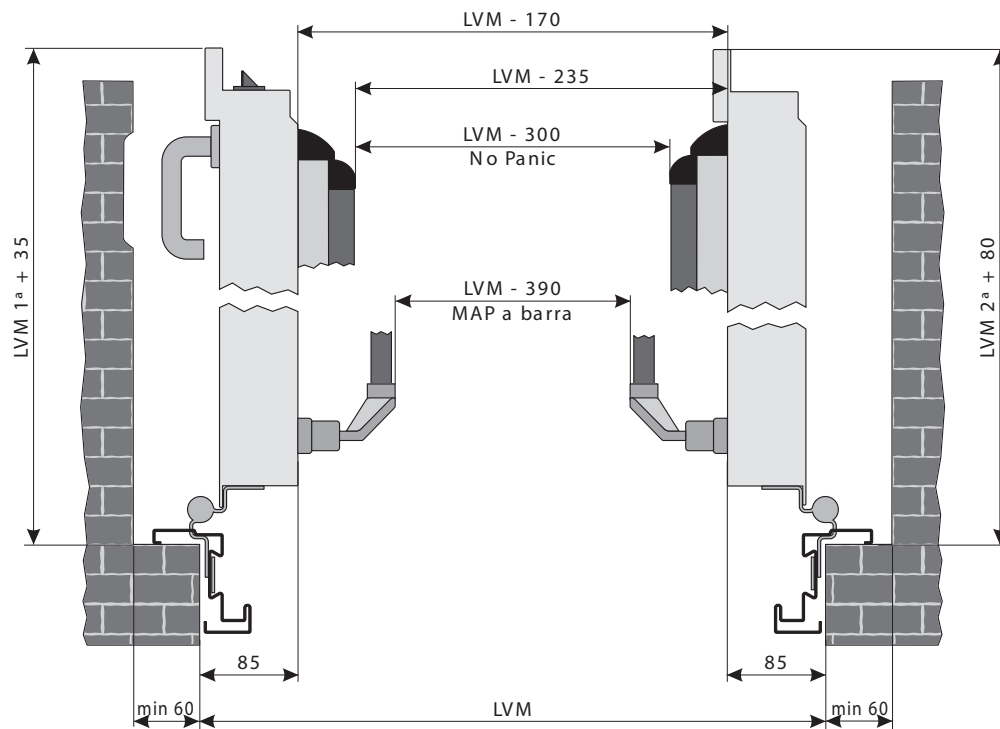

INGOMBRI PORTA CON APERTURA A 180°
 OPENING OVERALL DIMENSIONS WITH A 180° OPENING ANGLE

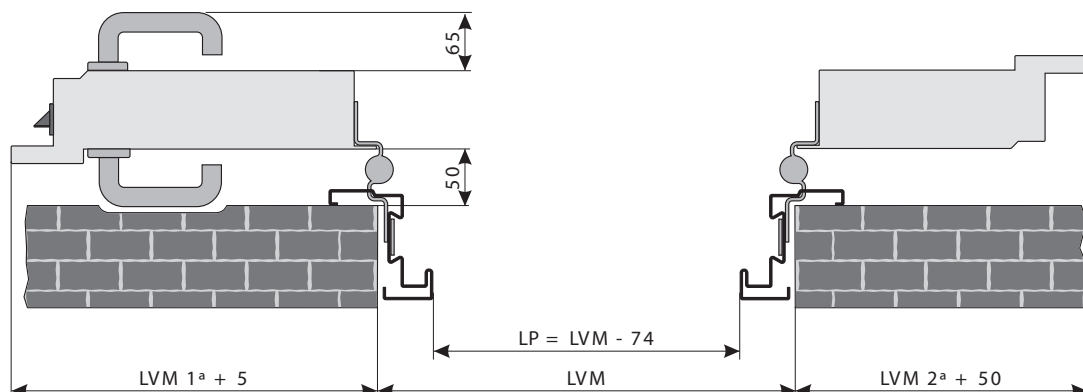

NEW IDRA FIREWALL DOOR 1 BATTENTE EI₂ 90
NEW IDRA FIREWALL DOOR SINGLE LEAF EI₂ 90

INGOMBRI PORTA CON APERTURA A 90°
OPENING OVERALL DIMENSIONS WITH A 90° OPENING ANGLE

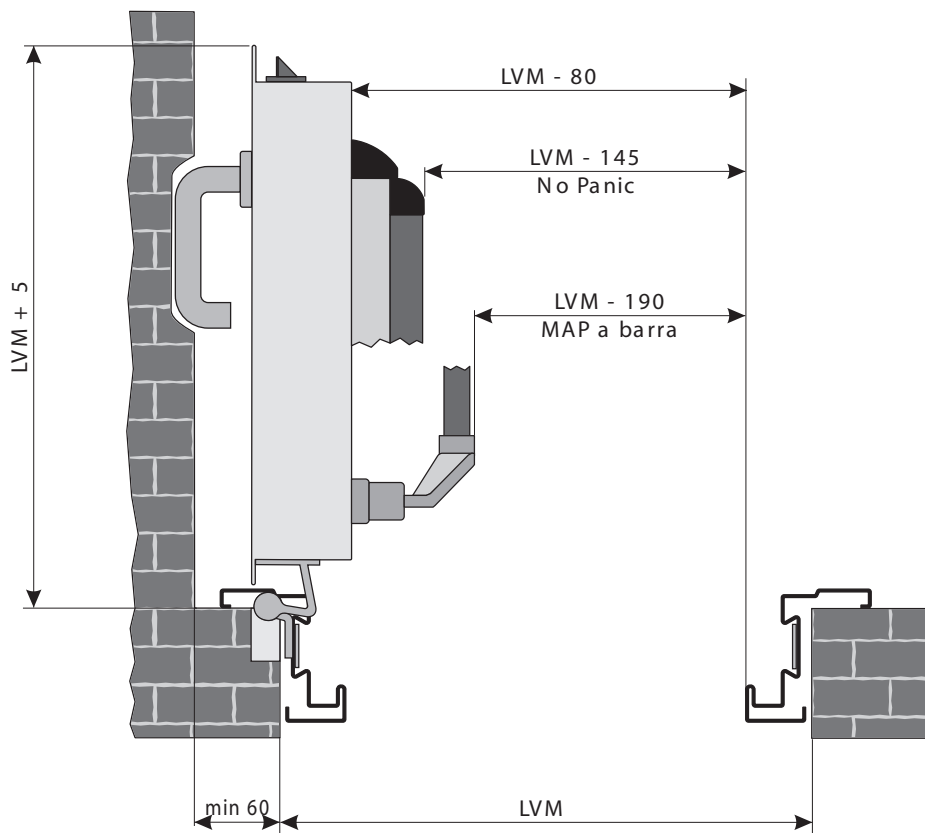

ATTENZIONE: MASSIMA APERTURA 100° CIRCA
ATTENTION: MAXIMUM OPENING ANGLE APPROX. 100°

IDRA 1 BATTENTE EI₂ 30 CON TELAIO STANDARD

IDRA SINGLE LEAF EI₂ 30 WITH STANDARD FRAME

INGOMBRI PORTA CON APERTURA A 90°

OPENING OVERALL DIMENSIONS WITH A 90° OPENING ANGLE

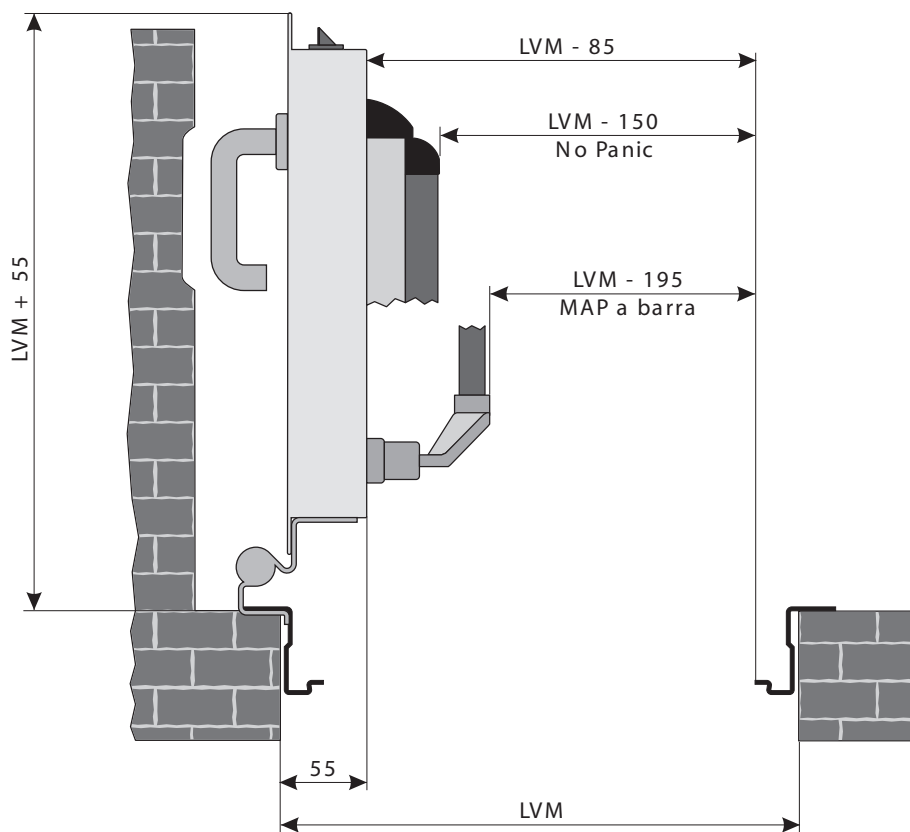

INGOMBRI PORTA CON APERTURA A 180°

OPENING OVERALL DIMENSIONS WITH A 180° OPENING ANGLE

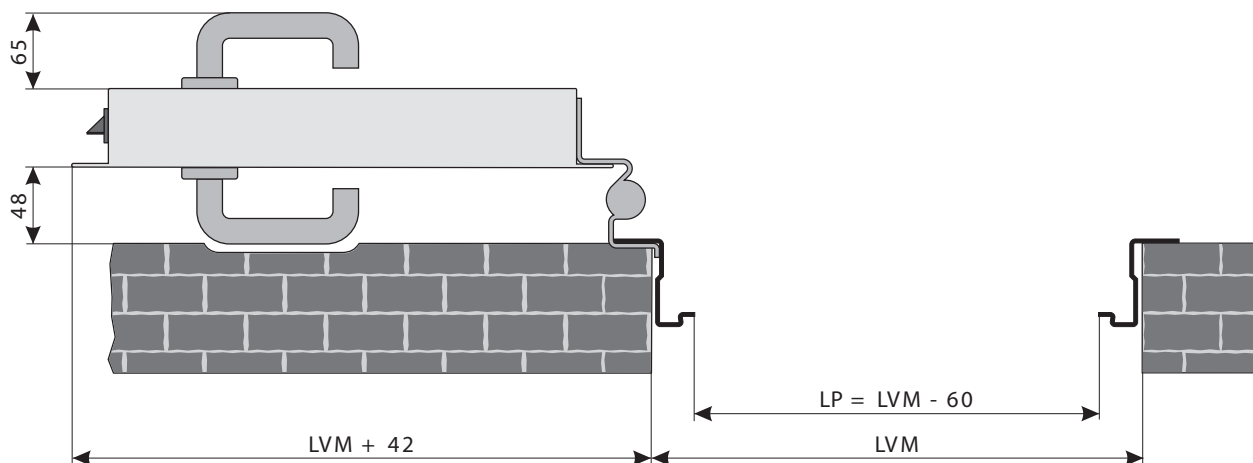

LE FINESTRATURE

GLAZING

	FINESTRATURE CON MISURE STANDARD STANDARD SIZE GLAZING		FINESTRATURE CON MISURE A SCELTA GLAZED AREA WITH SIZE UPON CLIENT'S CHOICE
	Lfin x Hfin	LARGHEZZA BATTENTE MIN. MINIMUM LEAF WIDTH	
	300 x 400	800	Lfin _{min} = 200 mm Hfin _{min} = 200 mm Se Lfin _{max} = 700 mm, Hfin _{max} = 600 mm Se Lfin _{max} = 600 mm, Hfin _{max} = 700 mm S _{min} = 250 mm S _{max} = LVM - 250 - Lfin W _{min} = 250 mm W _{max} = HVM - 250 - Hfin
	400 x 600	900	
	200 x 700	700	
	300 x 700	800	
	400 x 700	900	
	600 x 700	1100	
	300 x 400	800	Lfin _{1min} = 200 mm Hfin _{1min} = 200 mm Lfin _{1max} = 700 mm, Hfin _{1max} = 700 mm Lfin ₁ x Hfin ₁ = 0,24 m ² S _{1min} = 250 mm S _{1max} = LVM 1° - 250 - Lfin ₁ W _{1min} = 250 mm W _{1max} = HVM - 250 - Hfin ₁
	400 x 600	900	
	200 x 700	700	
	300 x 700	800	
	300 x 400	800	Lfin _{2min} = 200 mm Hfin _{2min} = 200 mm Se Lfin _{2max} = 700 mm, Hfin _{2max} = 700 mm Lfin ₂ x Hfin ₂ = 0,24 m ² S _{2min} = 250 mm S _{2max} = LVM 2° - 250 - Lfin ₂ W _{2min} = 250 mm W _{2max} = HVM - 250 - Hfin ₂
	400 x 600	900	
	200 x 700	700	
	300 x 700	800	

	FINESTRATURE CON MISURE STANDARD STANDARD SIZE GLAZING		FINESTRATURE CON MISURE A SCELTA GLAZED AREA WITH SIZE UPON CLIENT'S CHOICE
	Dfin	LARGHEZZA BATTENTE MIN. MINIMUM LEAF WIDTH	
	Ø 300	800	NON DISPONIBILE NOT AVAILABLE
	Ø 400	900	
	Ø 300	800	NON DISPONIBILE NOT AVAILABLE
	Ø 400	900	
	Ø 300	800	NON DISPONIBILE NOT AVAILABLE
	Ø 400	900	

SOPRALUCE E FIANCHILUCE

FANLIGHTS AND SIDELIGHTS

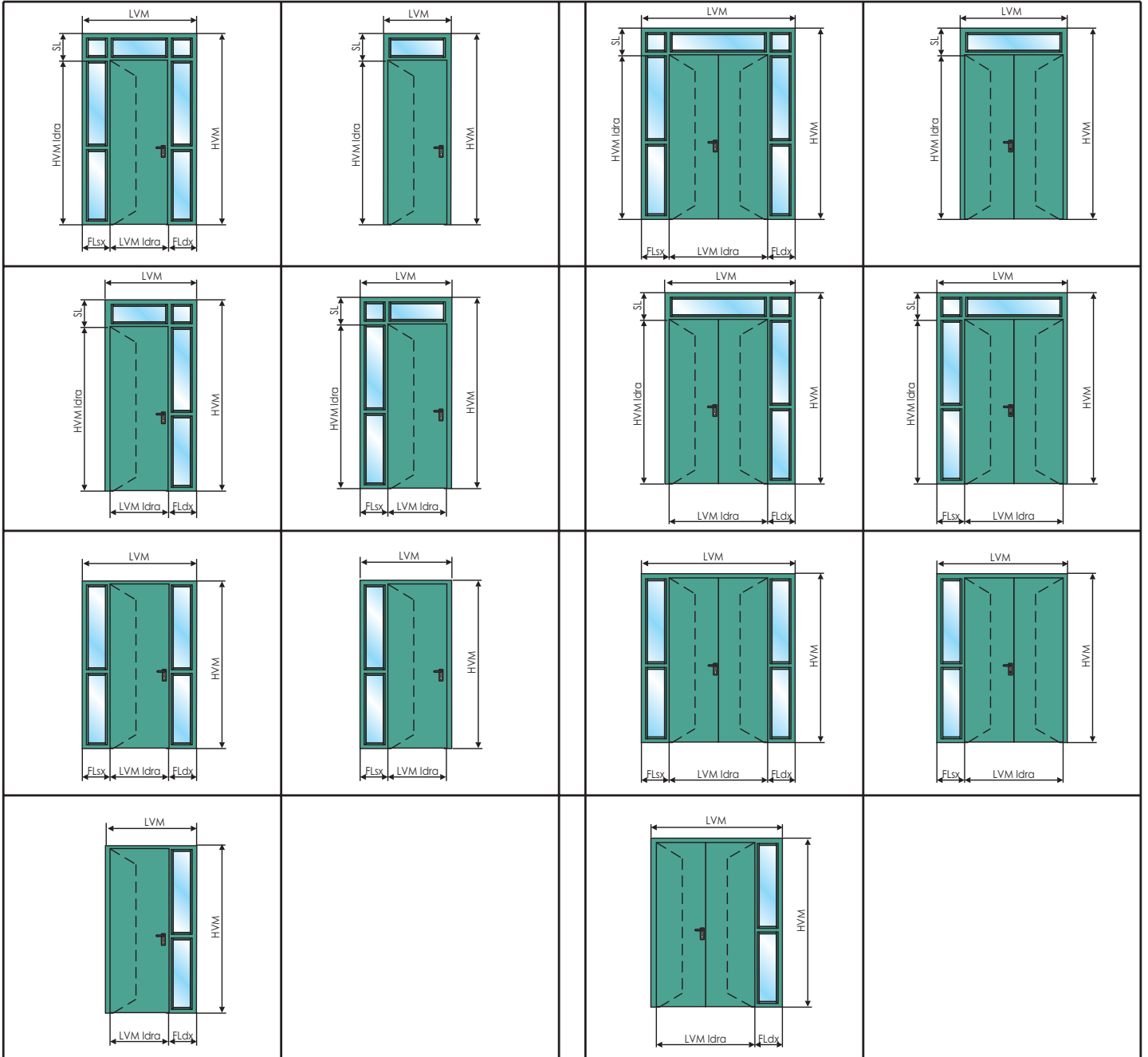

FINITURE MANIGLIONI NO PANIC

HANDLES NO PANIC FINISH



Nero/Rosso
Black/Red



Nero/Grigio
Black/Grey



Grigio
Grey

SCHEDE TECNICHE
TECHNICAL SHEETS

CARATTERISTICHE PRESTAZIONALI STANDARD
STANDARD PERFORMANCE FEATURES

TRASMITTANZA TERMICA
 THERMAL TRANSMITTANCE



1,8 W/m²K

ABBATTIMENTO ACUSTICO
 NOISE REDUCTION



19 dB

DI SERIE STANDARD

MANIGLIA + MANIGLIA CON SERRATURA ANTINCENDIO
 HANDLE + HANDLE WITH FIRE RESISTANT LOCK



CERNIERE A VISTA
 EXPOSED HINGES



PESO
 WEIGHT

35 kg/m²

CARATTERISTICHE PRESTAZIONALI SUPPLEMENTARI
OPTIONAL PERFORMANCE FEATURES

KIT FUMI FREDDI (S_d)
 COLD FUMES KIT (S_d)
 KIT FUMI CALDI (S_m/S₂₀₀)
 HOT FUMES KIT (S_m/S₂₀₀)



SI / YES

ABBATTIMENTO ACUSTICO con soglia mobile
 NOISE REDUCTION with mobile threshold



27 dB

ABBATTIMENTO ACUSTICO con soglia fissa
 (uscita NON CONFORME alle uscite d'emergenza)



34 dB

NOISE REDUCTION with fixed threshold
 (this exit is NOT COMPLIANT with emergency exit requirements)

PERMEABILITÀ ALL'ARIA E RESISTENZA AL CARICO DEL VENTO
 PERMEABILITY TO AIR AND RESISTANCE TO THE WIND LOAD



classe 4
 C4

PORTA PER ESTERNI EN 14351-1 *
 Abbinare sempre almeno la guarnizione di battuta
 EXTERNAL DOOR EN 14351-1 *
 Always match at least the door stop seal



SI / YES

VARIANTI SUPPLEMENTARI
ADDITIONAL VARIATIONS

FINISTRATURA RETTANGOLARE/OBLÒ
 (vedi limiti a pagina 22)
 SQUARE WINDOW / ROUND WINDOW
 (see limits on page 22)



SI / YES

SOPRALUCE/FIANCOLUCE
 FANLIGHT/SIDELIGHT



SI / YES

ZOCCOLO/FASCIA PARACOLPI
 BUMPER SKIRTING/BAND



SI / YES

CERNIERE A 3 ALI
 3-FLAP HINGES



SI / YES

MANIGLIERA ANTIPANICO
 PANIC EXIT BAR



SI / YES

SERRATURA A 3 PUNTI DI CHIUSURA
 3 LOCK POINTS LOCK



SI / YES

MANIGLIERA CONFORME ALLE NORME DIN
 DIN COMPLIANT HANDLES

SI / YES

CONTROLLO ACCESSI
ACCESS MONITORING

SBLOCCO ELETTRICO
 ELECTRIC UNLOCK

SI / YES

ELETTROMANIGLIA
 ELECTROHANDLE

SI / YES

SERRATURA ELETTRICA
 ELECTRIC LOCK

SI / YES

ELETTROMAGNETI
 ELECTROMAGNETS

SI / YES

ELETTROBLOCCHI MAGNETICI
 MAGNETIC ELECTRIC BLOCKS

SI / YES

DIMENSIONI CERTIFICATE (Per la disponibilità nella propria nazione, chiedere al ns ufficio tecnico)
CERTIFIED DIMENSIONS (Ask our technical assistance office for availability in your country)

LARGHEZZA (LVM)
 WIDTH (LVM)

675 ÷ 1350

ALTEZZA (HVM)
 HEIGHT (HVM)

1987 ÷ 2650

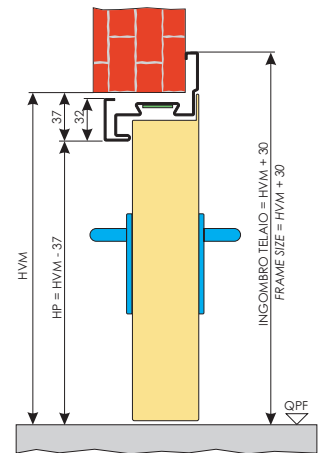
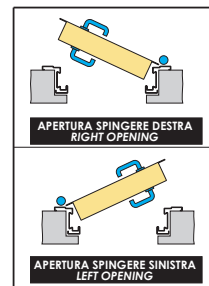
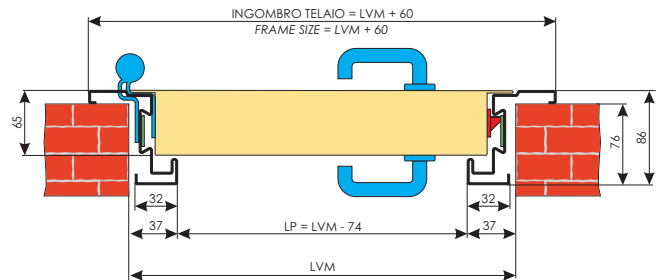

I disegni sono esemplificativi e fuori scala
 Dierre si riserva il cambiamento della presente senza preavviso
 Le quote sono espresse in millimetri

Drawing are examples and not in scale
 Dierre holds the right to change this without notice
 Dimensions are expressed in millimetres

* Per la compatibilità con i vari extra consultare il listino prezzi
 For compatibility with the various extras refer to the price list

FINITURE
FINISHINGS

LACCATA RAL PER ESTERNI
 EXTERIOR RAL LACQUER

SI / YES

IN ACCIAIO INOX
 STAINLESS STEEL

SI / YES

IN ACCIAIO PRERIVESTITO
 PRE-COATED STEEL

SI / YES

TIPOLOGIE DI MONTAGGIO
MOUNTING SOLUTIONS

CON ZANCHE
 WITH TIES



SU CONTROTELAIO
 ON SUB-FRAME



CON TASSELLI
 WITH BOLTS



SU MAZZETTA
 ON REVEAL



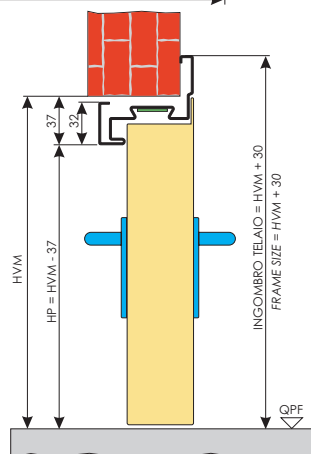
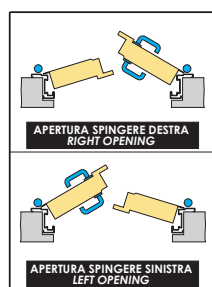
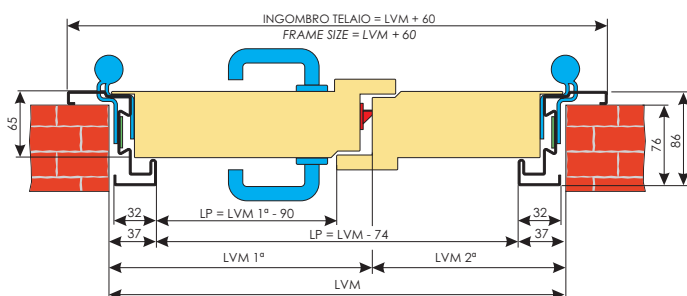
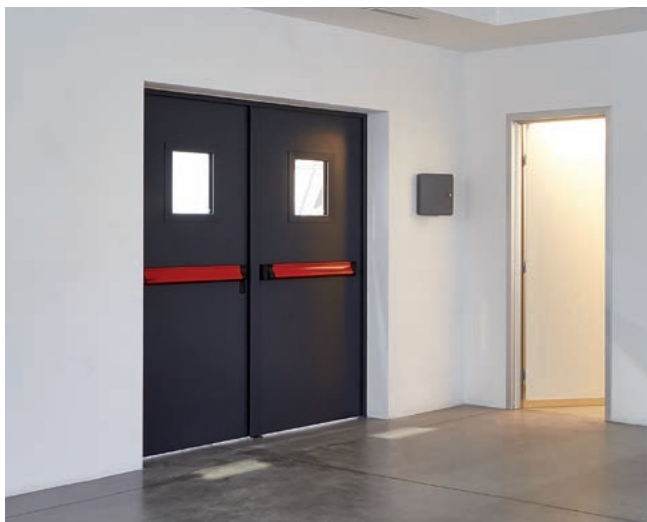

I disegni sono esemplificativi e fuori scala
Dierre si riserva il cambiamento della presente senza preavviso
Le quote sono espresse in millimetri

Drawing are examples and not in scale
Dierre holds the right to change this without notice
Dimensions are expressed in millimetres

* Per la compatibilità con i vari extra consultare il listino prezzi
For compatibility with the various extras refer to the price list

FINITURE FINISHINGS

LACCATA RAL PER ESTERNI EXTERIOR RAL LACQUER	SI / YES
IN ACCIAIO INOX STAINLESS STEEL	SI / YES
IN ACCIAIO PRERIVESTITO PRE-COATED STEEL	SI / YES

TIPOLOGIE DI MONTAGGIO MOUNTING SOLUTIONS

CON ZANCHE WITH TIES	
SU CONTROTELAIO ON SUB-FRAME	
CON TASSELLI WITH BOLTS	
SU MAZZETTA ON REVEAL	

CARATTERISTICHE PRESTAZIONALI STANDARD STANDARD PERFORMANCE FEATURES

TRASMITTANZA TERMICA
THERMAL TRANSMITTANCE



2,2 W/m²K

ABBATTIMENTO ACUSTICO
NOISE REDUCTION



19 dB

DI SERIE STANDARD

MANIGLIA + MANIGLIA CON SERRATURA ANTINCENDIO
HANDLE + HANDLE WITH FIRE RESISTANT LOCK



CERNIERE A VISTA
EXPOSED HINGES



PESO
WEIGHT

35 kg/m²

CARATTERISTICHE PRESTAZIONALI SUPPLEMENTARI OPTIONAL PERFORMANCE FEATURES

KIT FUMI FREDDI (S₂)
COLD FUMES KIT (S₂)
KIT FUMI CALDI (S_m/S₂₀₀)
HOT FUMES KIT (S_m/S₂₀₀)



SI / YES

ABBATTIMENTO ACUSTICO con soglia mobile
NOISE REDUCTION with mobile threshold



25 dB

ABBATTIMENTO ACUSTICO con soglia fissa
(uscita NON CONFORME alle uscite d'emergenza)



30 dB

NOISE REDUCTION with fixed threshold
(this exit is NOT COMPLIANT with emergency exit requirements)

PERMEABILITÀ ALL'ARIA E RESISTENZA AL CARICO DEL VENTO
PERMEABILITY TO AIR AND RESISTANCE TO THE WIND LOAD



classe 4
C4

PORTA PER ESTERNI EN 14351-1 *
Abbinare sempre almeno la guarnizione di battuta
EXTERNAL DOOR EN 14351-1 *
Always match at least the door stop seal



SI / YES

VARIANTI SUPPLEMENTARI ADDITIONAL VARIATIONS

FINISTRATURA RETTANGOLARE/OBLÒ
(vedi limiti a pagina 22)
SQUARE WINDOW / ROUND WINDOW
(see limits on page 22)



SI / YES

SOPRALUCE/FIANCOLUCE
FANLIGHT/SIDELIGHT



SI / YES

ZOCCOLO/FASCIA PARACOLPI
BUMPER SKIRTING/BAND



SI / YES

CERNIERE A 3 ALI
3-FLAP HINGES



SI / YES

MANIGLIERIA ANTIPANICO
PANIC EXIT BAR



SI / YES

SERRATURA A 3 PUNTI DI CHIUSURA
3 LOCK POINTS LOCK



SI / YES

MANIGLIERIA CONFORME ALLE NORME DIN
DIN COMPLIANT HANDLES

SI / YES

CONTROLLO ACCESSI ACCESS MONITORING

SBLOCCO ELETTRICO
ELECTRIC UNLOCK

SI / YES

ELETTROMANIGLIA
ELECTROHANDLE

SI / YES

SERRATURA ELETTRICA
ELECTRIC LOCK

SI / YES

ELETTROMAGNETI
ELECTROMAGNETS

SI / YES

ELETTROBLOCCHI MAGNETICI
MAGNETIC ELECTRIC BLOCKS

SI / YES

DIMENSIONI CERTIFICATE (Per la disponibilità nella propria nazione, chiedere al ns ufficio tecnico) CERTIFIED DIMENSIONS (Ask our technical assistance office for availability in your country)

LARGHEZZA (LVM) WIDTH (LVM)	950 ÷ 2600 (600 + 350) ÷ (1300 + 1300)
ALTEZZA (HVM) HEIGHT (HVM)	1987 ÷ 2650

CARATTERISTICHE PRESTAZIONALI STANDARD
STANDARD PERFORMANCE FEATURES

TRASMITTANZA TERMICA
 THERMAL TRANSMITTANCE



1,8 W/m²K

ABBATTIMENTO ACUSTICO
 NOISE REDUCTION



19 dB

DI SERIE STANDARD

MANIGLIA + MANIGLIA CON SERRATURA ANTINCENDIO
 HANDLE + HANDLE WITH FIRE RESISTANT LOCK



CERNIERE A VISTA
 EXPOSED HINGES



PESO
 WEIGHT

35 kg/m²

CARATTERISTICHE PRESTAZIONALI SUPPLEMENTARI
OPTIONAL PERFORMANCE FEATURES

KIT FUMI FREDDI (S_e)
 COLD FUMES KIT (S_e)
 KIT FUMI CALDI (S_m/S₂₀₀)
 HOT FUMES KIT (S_m/S₂₀₀)



SI / YES

ABBATTIMENTO ACUSTICO con soglia mobile
 NOISE REDUCTION with mobile threshold



27 dB

ABBATTIMENTO ACUSTICO con soglia fissa
 (uscita NON CONFORME alle uscite d'emergenza)



34 dB

NOISE REDUCTION with fixed threshold
 (this exit is NOT COMPLIANT with emergency exit requirements)

PERMEABILITÀ ALL'ARIA E RESISTENZA AL CARICO DEL VENTO
 PERMEABILITY TO AIR AND RESISTANCE TO THE WIND LOAD



classe 4
 C4

PORTA PER ESTERNI EN 14351-1 *

Abbinare sempre almeno la guarnizione di battuta
 EXTERNAL DOOR EN 14351-1 *
 Always match at least the door stop seal



SI / YES

VARIANTI SUPPLEMENTARI
ADDITIONAL VARIATIONS

FINISTRATURA RETTANGOLARE/OBLÒ
 (vedi limiti a pagina 22)
 SQUARE WINDOW / ROUND WINDOW
 (see limits on page 22)



SI / YES

SOPRALUCE/FIANCOLUCE
 FANLIGHT/SIDELIGHT



NO

ZOCCOLO/FASCIA PARACOLPI
 BUMPER SKIRTING/BAND



SI / YES

CERNIERE A 3 ALI
 3-FLAP HINGES



SI / YES

MANIGLIERA ANTIPANICO
 PANIC EXIT BAR



SI / YES

SERRATURA A 3 PUNTI DI CHIUSURA
 3 LOCK POINTS LOCK



SI / YES

MANIGLIERA CONFORME ALLE NORME DIN
 DIN COMPLIANT HANDLES

SI / YES

CONTROLLO ACCESSI
ACCESS MONITORING

SBLOCCO ELETTRICO
 ELECTRIC UNLOCK

SI / YES

ELETTROMANIGLIA
 ELECTROHANDLE

SI / YES

SERRATURA ELETTRICA
 ELECTRIC LOCK

SI / YES

ELETTROMAGNETI
 ELECTROMAGNETS

SI / YES

ELETTROBLOCCHI MAGNETICI
 MAGNETIC ELECTRIC BLOCKS

SI / YES

DIMENSIONI CERTIFICATE (Per la disponibilità nella propria nazione, chiedere al ns ufficio tecnico)
CERTIFIED DIMENSIONS (Ask our technical assistance office for availability in your country)

LARGHEZZA (LVM)
 WIDTH (LVM)

675 ÷ 1350

ALTEZZA (HVM)
 HEIGHT (HVM)

1987 ÷ 2650

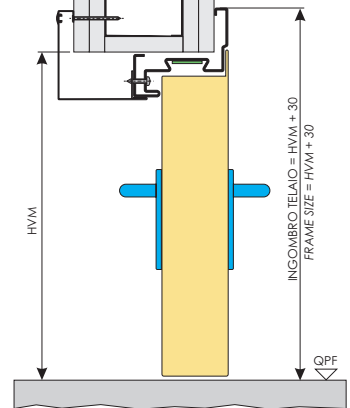
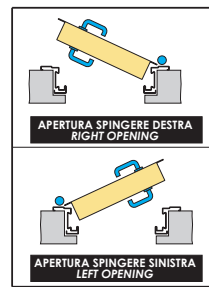
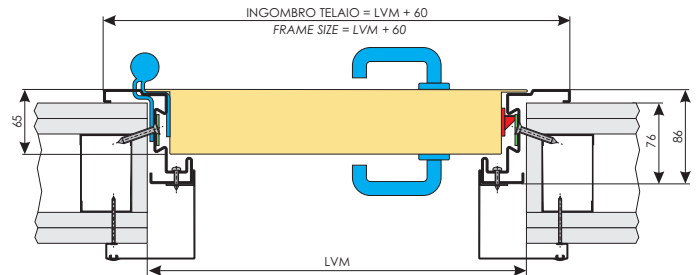

I disegni sono esemplificativi e fuori scala
 Dierre si riserva il cambiamento della presente senza preavviso
 Le quote sono espresse in millimetri

Drawing are examples and not in scale
 Dierre holds the right to change this without notice
 Dimensions are expressed in millimetres

L'imbotte non è necessario con la marcatura CE
 The padding is not necessary with the CE marking

* Per la compatibilità con i vari extra consultare il listino prezzi
 For compatibility with the various extras refer to the price list

FINITURE
FINISHINGS

LACCATA RAL PER ESTERNI
 EXTERIOR RAL LACQUER

SI / YES

IN ACCIAIO INOX
 STAINLESS STEEL

SI / YES

IN ACCIAIO PRERIVESTITO
 PRE-COATED STEEL

SI / YES

TIPOLOGIE DI MONTAGGIO
MOUNTING SOLUTIONS

SU PARETI IN CARTONGESSO
 ON PLASTERBOARD WALLS



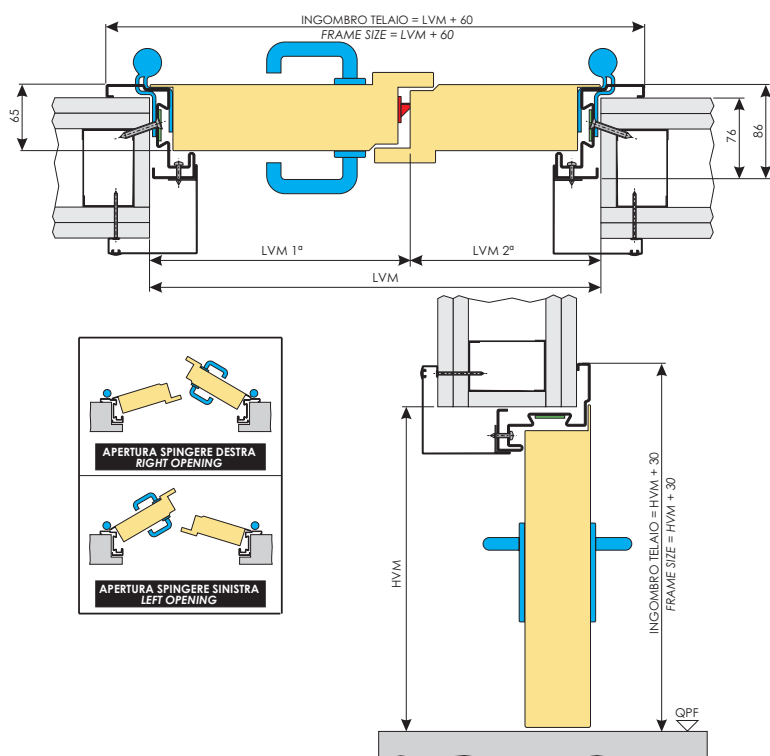

I disegni sono esemplificativi e fuori scala
Dierre si riserva il cambiamento della presente senza preavviso
Le quote sono espresse in millimetri

Drawing are examples and not in scale
Dierre holds the right to change this without notice
Dimensions are expressed in millimetres

L'imbotte non è necessario con la marcatura CE
The padding is not necessary with the CE marking

* Per la compatibilità con i vari extra consultare il listino prezzi
For compatibility with the various extras refer to the price list

FINITURE FINISHINGS

LACCATA RAL PER ESTERNI EXTERIOR RAL LACQUER	SI / YES
IN ACCIAIO INOX STAINLESS STEEL	SI / YES
IN ACCIAIO PRERIVESTITO PRE-COATED STEEL	SI / YES

TIPOLOGIE DI MONTAGGIO MOUNTING SOLUTIONS

SU PARETI IN CARTONGESSO
ON PLASTERBOARD WALLS



CARATTERISTICHE PRESTAZIONALI STANDARD STANDARD PERFORMANCE FEATURES

TRASMITTANZA TERMICA
THERMAL TRANSMITTANCE



2,2 W/m²K

ABBATTIMENTO ACUSTICO
NOISE REDUCTION



19 dB

DI SERIE STANDARD

MANIGLIA + MANIGLIA CON SERRATURA ANTINCENDIO
HANDLE + HANDLE WITH FIRE RESISTANT LOCK



CERNIERE A VISTA
EXPOSED HINGES



PESO
WEIGHT

35 kg/m²

CARATTERISTICHE PRESTAZIONALI SUPPLEMENTARI OPTIONAL PERFORMANCE FEATURES

KIT FUMI FREDDI (S₂)
COLD FUMES KIT (S₂)
KIT FUMI CALDI (S_m/S₂₀₀)
HOT FUMES KIT (S_m/S₂₀₀)



SI / YES

ABBATTIMENTO ACUSTICO con soglia mobile
NOISE REDUCTION with mobile threshold



25 dB

ABBATTIMENTO ACUSTICO con soglia fissa
(uscita NON CONFORME alle uscite d'emergenza)

NOISE REDUCTION with fixed threshold
(this exit is NOT COMPLIANT with emergency exit requirements)



30 dB

PERMEABILITÀ ALL'ARIA E RESISTENZA AL CARICO DEL VENTO
PERMEABILITY TO AIR AND RESISTANCE TO THE WIND LOAD



classe 4
C4

PORTA PER ESTERNI EN 14351-1 *
Abbinare sempre almeno la guarnizione di battuta
EXTERNAL DOOR EN 14351-1 *
Always match at least the door stop seal



SI / YES

VARIANTI SUPPLEMENTARI ADDITIONAL VARIATIONS

FINISTRATURA RETTANGOLARE/OBLÒ
(vedi limiti a pagina 22)
SQUARE WINDOW / ROUND WINDOW
(see limits on page 22)



SI / YES

SOPRALUCE/FIANCOLUCE
FANLIGHT/SIDELIGHT



NO

ZOCCOLO/FASCIA PARACOLPI
BUMPER SKIRTING/BAND



SI / YES

CERNIERE A 3 ALI
3-FLAP HINGES



SI / YES

MANIGLIERIA ANTIPANICO
PANIC EXIT BAR



SI / YES

SERRATURA A 3 PUNTI DI CHIUSURA
3 LOCK POINTS LOCK



SI / YES

MANIGLIERIA CONFORME ALLE NORME DIN
DIN COMPLIANT HANDLES

SI / YES

CONTROLLO ACCESSI ACCESS MONITORING

SBLOCCO ELETTRICO
ELECTRIC UNLOCK

SI / YES

ELETTROMANIGLIA
ELECTROHANDLE

SI / YES

SERRATURA ELETTRICA
ELECTRIC LOCK

SI / YES

ELETTROMAGNETI
ELECTROMAGNETS

SI / YES

ELETTROBLOCCHI MAGNETICI
MAGNETIC ELECTRIC BLOCKS

SI / YES

DIMENSIONI CERTIFICATE (Per la disponibilità nella propria nazione, chiedere al ns ufficio tecnico) CERTIFIED DIMENSIONS (Ask our technical assistance office for availability in your country)

LARGHEZZA (LVM)
WIDTH (LVM)

1150 ÷ 2300
(575 + 575) ÷ (1150 + 1150)

ALTEZZA (HVM)
HEIGHT (HVM)

1987 ÷ 2650

CARATTERISTICHE PRESTAZIONALI STANDARD
STANDARD PERFORMANCE FEATURES

TRASMITTANZA TERMICA
THERMAL TRANSMITTANCE



1,8 W/m²K

ABBATTIMENTO ACUSTICO
NOISE REDUCTION



20 dB

DI SERIE STANDARD

MANIGLIA + MANIGLIA CON SERRATURA ANTINCENDIO
HANDLE + HANDLE WITH FIRE RESISTANT LOCK



CERNIERE A VISTA
EXPOSED HINGES



PESO
WEIGHT

40 kg/m²

CARATTERISTICHE PRESTAZIONALI SUPPLEMENTARI
OPTIONAL PERFORMANCE FEATURES

KIT FUMI FREDDI (S_e)
COLD FUMES KIT (S_e)
KIT FUMI CALDI (S_m/S₂₀₀)
HOT FUMES KIT (S_m/S₂₀₀)



SI / YES

ABBATTIMENTO ACUSTICO con soglia mobile
NOISE REDUCTION with mobile threshold



29 dB

ABBATTIMENTO ACUSTICO con soglia fissa
(uscita NON CONFORME alle uscite d'emergenza)

NOISE REDUCTION with fixed threshold
(this exit is NOT COMPLIANT with emergency exit requirements)



35 dB

PERMEABILITÀ ALL'ARIA E RESISTENZA AL CARICO DEL VENTO
PERMEABILITY TO AIR AND RESISTANCE TO THE WIND LOAD



classe 4
C4

PORTA PER ESTERNI EN 14351-1 *
Abbinare sempre almeno la guarnizione di battuta
EXTERNAL DOOR EN 14351-1 *
Always match at least the door stop seal



SI / YES

VARIANTI SUPPLEMENTARI
ADDITIONAL VARIATIONS

FINISTRATURA RETTANGOLARE/OBLÒ
(vedi limiti a pagina 22)
SQUARE WINDOW / ROUND WINDOW
(see limits on page 22)



SI / YES

SOPRALUCE/FIANCOLUCE
FANLIGHT/SIDELIGHT



SI / YES

ZOCCOLO/FASCIA PARACOLPI
BUMPER SKIRTING/BAND



SI / YES

CERNIERE A 3 ALI
3-FLAP HINGES



SI / YES

MANIGLIERA ANTIPANICO
PANIC EXIT BAR



SI / YES

SERRATURA A 3 PUNTI DI CHIUSURA
3 LOCK POINTS LOCK



SI / YES

MANIGLIERA CONFORME ALLE NORME DIN
DIN COMPLIANT HANDLES

SI / YES

CONTROLLO ACCESSI
ACCESS MONITORING

SBLOCCO ELETTRICO
ELECTRIC UNLOCK

SI / YES

ELETTROMANIGLIA
ELECTROHANDLE

SI / YES

SERRATURA ELETTRICA
ELECTRIC LOCK

SI / YES

ELETTROMAGNETI
ELECTROMAGNETS

SI / YES

ELETTROBLOCCHI MAGNETICI
MAGNETIC ELECTRIC BLOCKS

SI / YES

DIMENSIONI CERTIFICATE (Per la disponibilità nella propria nazione, chiedere al ns ufficio tecnico)
CERTIFIED DIMENSIONS (Ask our technical assistance office for availability in your country)

LARGHEZZA (LVM)
WIDTH (LVM)

675 ÷ 1350

ALTEZZA (HVM)
HEIGHT (HVM)

1987 ÷ 2650

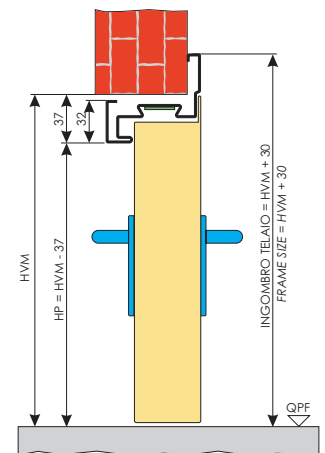
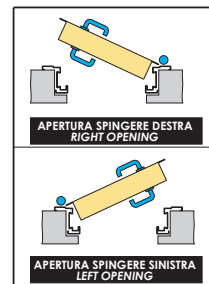
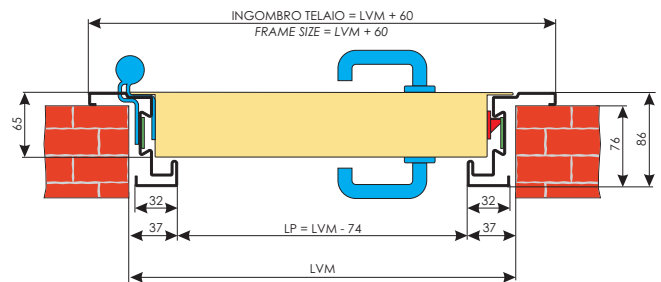

I disegni sono esemplificativi e fuori scala
Dierre si riserva il cambiamento della presente senza preavviso
Le quote sono espresse in millimetri

Drawing are examples and not in scale
Dierre holds the right to change this without notice
Dimensions are expressed in millimetres

* Per la compatibilità con i vari extra consultare il listino prezzi
For compatibility with the various extras refer to the price list

FINITURE
FINISHINGS

LACCATA RAL PER ESTERNI
EXTERIOR RAL LACQUER

SI / YES

IN ACCIAIO INOX
STAINLESS STEEL

SI / YES

IN ACCIAIO PRERIVESTITO
PRE-COATED STEEL

SI / YES

TIPOLOGIE DI MONTAGGIO
MOUNTING SOLUTIONS

CON ZANCHE
WITH TIES



SU CONTROTELAIO
ON SUB-FRAME



CON TASSELLI
WITH BOLTS



SU MAZZETTA
ON REVEAL



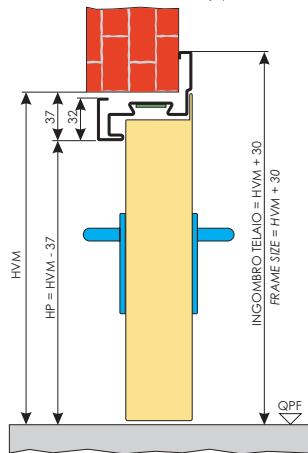
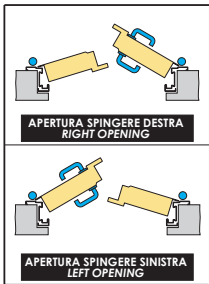
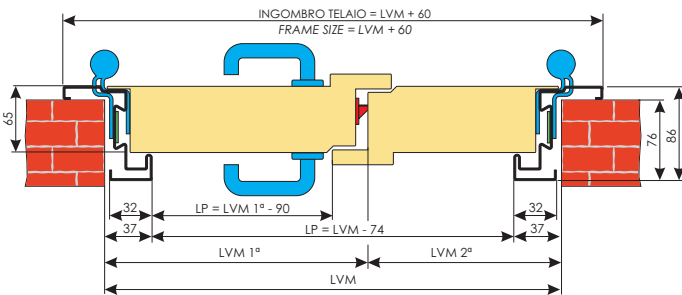

I disegni sono esemplificativi e fuori scala
Dierre si riserva il cambiamento della presente senza preavviso
Le quote sono espresse in millimetri

Drawing are examples and not in scale
Dierre holds the right to change this without notice
Dimensions are expressed in millimetres

* Per la compatibilità con i vari extra consultare il listino prezzi
For compatibility with the various extras refer to the price list

FINITURE FINISHINGS	
LACCATA RAL PER ESTERNI EXTERIOR RAL LACQUER	SI / YES
IN ACCIAIO INOX STAINLESS STEEL	NO
IN ACCIAIO PRERIVESTITO PRE-COATED STEEL	SI / YES
TIPOLOGIE DI MONTAGGIO MOUNTING SOLUTIONS	
CON ZANCHE WITH TIES	
SU CONTROTELAIO ON SUB-FRAME	
CON TASSELLI WITH BOLTS	
SU MAZZETTA ON REVEAL	

**CARATTERISTICHE PRESTAZIONALI STANDARD
STANDARD PERFORMANCE FEATURES**

TRASMITTANZA TERMICA THERMAL TRANSMITTANCE		2,2 W/m ² K
ABBATTIMENTO ACUSTICO NOISE REDUCTION		N.D.
DI SERIE STANDARD		
MANIGLIA + MANIGLIA CON SERRATURA ANTINCENDIO HANDLE + HANDLE WITH FIRE RESISTANT LOCK		
CERNIERE A VISTA EXPOSED HINGES		
PESO WEIGHT		40 kg/m ²

**CARATTERISTICHE PRESTAZIONALI SUPPLEMENTARI
OPTIONAL PERFORMANCE FEATURES**

KIT FUMI FREDDI (S _d) COLD FUMES KIT (S _d) KIT FUMI CALDI (S _m /S ₂₀₀) HOT FUMES KIT (S _m /S ₂₀₀)		SI / YES
ABBATTIMENTO ACUSTICO con soglia mobile NOISE REDUCTION with mobile threshold		32 dB
ABBATTIMENTO ACUSTICO con soglia fissa (uscita NON CONFORME alle uscite d'emergenza) NOISE REDUCTION with fixed threshold (this exit is NOT COMPLIANT with emergency exit requirements)		36 dB
PERMEABILITÀ ALL'ARIA E RESISTENZA AL CARICO DEL VENTO PERMEABILITY TO AIR AND RESISTANCE TO THE WIND LOAD		classe 4 C4
PORTA PER ESTERNI EN 14351-1 * Abbinare sempre almeno la guarnizione di battuta EXTERNAL DOOR EN 14351-1 * Always match at least the door stop seal		SI / YES

**VARIANTI SUPPLEMENTARI
ADDITIONAL VARIATIONS**

FINISTRATURA RETTANGOLARE/OBLÒ (vedi limiti a pagina 22) SQUARE WINDOW / ROUND WINDOW (see limits on page 22)		SI / YES
SOPRALUCE/FIANCOLUCE FANLIGHT/SIDELIGHT		SI / YES
ZOCOLO/FASCIA PARACOLPI BUMPER SKIRTING/BAND		SI / YES
CERNIERE A 3 ALI 3-FLAP HINGES		SI / YES
MANIGLIERIA ANTIPANICO PANIC EXIT BAR		SI / YES
SERRATURA A 3 PUNTI DI CHIUSURA 3 LOCK POINTS LOCK		SI / YES
MANIGLIERIA CONFORME ALLE NORME DIN DIN COMPLIANT HANDLES		SI / YES

**CONTROLLO ACCESSI
ACCESS MONITORING**

SBLOCCO ELETTRICO ELECTRIC UNLOCK		SI / YES
ELETTROMANIGLIA ELECTROHANDLE		SI / YES
SERRATURA ELETTRICA ELECTRIC LOCK		SI / YES
ELETTROMAGNETI ELECTROMAGNETS		SI / YES
ELETTROBLOCCHI MAGNETICI MAGNETIC ELECTRIC BLOCKS		SI / YES

**DIMENSIONI CERTIFICATE (Per la disponibilità nella propria nazione, chiedere al ns ufficio tecnico)
CERTIFIED DIMENSIONS (Ask our technical assistance office for availability in your country)**

LARGHEZZA (LVM) WIDTH (LVM)	950 ÷ 2600 (600 + 350) ÷ (1300 + 1300)
ALTEZZA (HVM) HEIGHT (HVM)	1987 ÷ 2650

CARATTERISTICHE PRESTAZIONALI STANDARD
STANDARD PERFORMANCE FEATURES

TRASMITTANZA TERMICA
 THERMAL TRANSMITTANCE



1,8 W/m²K

ABBATTIMENTO ACUSTICO
 NOISE REDUCTION



20 dB

DI SERIE STANDARD

MANIGLIA + MANIGLIA CON SERRATURA ANTINCENDIO
 HANDLE + HANDLE WITH FIRE RESISTANT LOCK



CERNIERE A VISTA
 EXPOSED HINGES



PESO
 WEIGHT

40 kg/m²

CARATTERISTICHE PRESTAZIONALI SUPPLEMENTARI
OPTIONAL PERFORMANCE FEATURES

KIT FUMI FREDDI (S_c)
 COLD FUMES KIT (S_c)
 KIT FUMI CALDI (S_m/S₂₀₀)
 HOT FUMES KIT (S_m/S₂₀₀)



SI / YES

ABBATTIMENTO ACUSTICO con soglia mobile
 NOISE REDUCTION with mobile threshold



29 dB

ABBATTIMENTO ACUSTICO con soglia fissa
 (uscita NON CONFORME alle uscite d'emergenza)

NOISE REDUCTION with fixed threshold
 (this exit is NOT COMPLIANT with emergency exit requirements)



35 dB

PERMEABILITÀ ALL'ARIA E RESISTENZA AL CARICO DEL VENTO
 PERMEABILITY TO AIR AND RESISTANCE TO THE WIND LOAD



classe 4
 C4

PORTA PER ESTERNI EN 14351-1 *
 Abbinare sempre almeno la guarnizione di battuta
 EXTERNAL DOOR EN 14351-1 *
 Always match at least the door stop seal



SI / YES

VARIANTI SUPPLEMENTARI
ADDITIONAL VARIATIONS

FINISTRATURA RETTANGOLARE/OBLÒ
 (vedi limiti a pagina 22)
 SQUARE WINDOW / ROUND WINDOW
 (see limits on page 22)



SI / YES

SOPRALUCE/FIANCOLUCE
 FANLIGHT/SIDELIGHT



NO

ZOCCOLO/FASCIA PARACOLPI
 BUMPER SKIRTING/BAND



SI / YES

CERNIERE A 3 ALI
 3-FLAP HINGES



SI / YES

MANIGLIERA ANTIPANICO
 PANIC EXIT BAR



SI / YES

SERRATURA A 3 PUNTI DI CHIUSURA
 3 LOCK POINTS LOCK



SI / YES

MANIGLIERA CONFORME ALLE NORME DIN
 DIN COMPLIANT HANDLES

SI / YES

CONTROLLO ACCESSI
ACCESS MONITORING

SBLOCCO ELETTRICO
 ELECTRIC UNLOCK

SI / YES

ELETTROMANIGLIA
 ELECTROHANDLE

SI / YES

SERRATURA ELETTRICA
 ELECTRIC LOCK

SI / YES

ELETTROMAGNETI
 ELECTROMAGNETS

SI / YES

ELETTROBLOCCHI MAGNETICI
 MAGNETIC ELECTRIC BLOCKS

SI / YES

DIMENSIONI CERTIFICATE (Per la disponibilità nella propria nazione, chiedere al ns ufficio tecnico)
CERTIFIED DIMENSIONS (Ask our technical assistance office for availability in your country)

LARGHEZZA (LVM)
 WIDTH (LVM)

675 ÷ 1350

ALTEZZA (HVM)
 HEIGHT (HVM)

1987 ÷ 2650

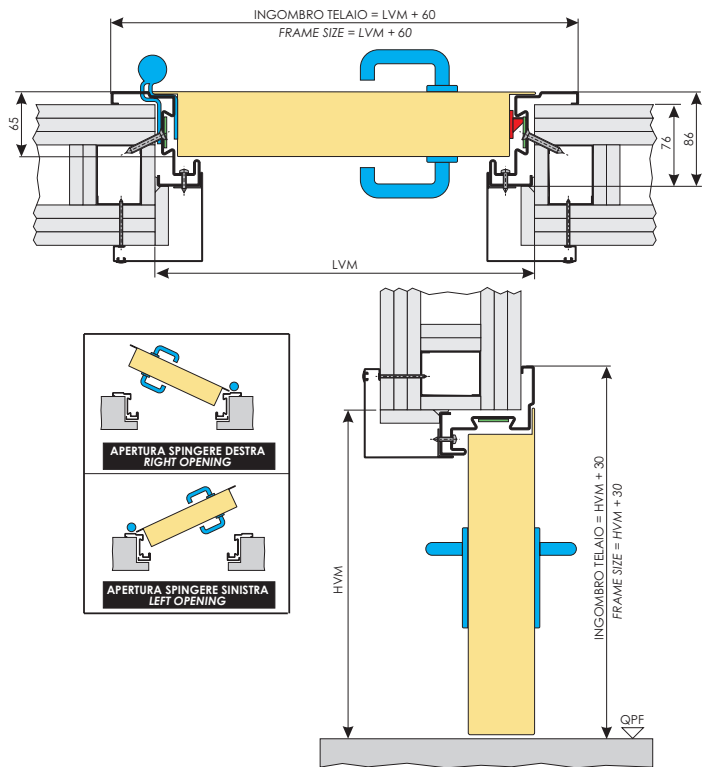

I disegni sono esemplificativi e fuori scala
 Dierre si riserva il cambiamento della presente senza preavviso
 Le quote sono espresse in millimetri

Drawing are examples and not in scale
 Dierre holds the right to change this without notice
 Dimensions are expressed in millimetres

L'imbotte non è necessario con la marcatura CE
 The padding is not necessary with the CE marking

* Per la compatibilità con i vari extra consultare il listino prezzi
 For compatibility with the various extras refer to the price list

FINITURE
FINISHINGS

LACCATA RAL PER ESTERNI
 EXTERIOR RAL LACQUER

SI / YES

IN ACCIAIO INOX
 STAINLESS STEEL

SI / YES

IN ACCIAIO PRERIVESTITO
 PRE-COATED STEEL

SI / YES

TIPOLOGIE DI MONTAGGIO
MOUNTING SOLUTIONS

SU PARETI IN CARTONGESSO
 ON PLASTERBOARD WALLS



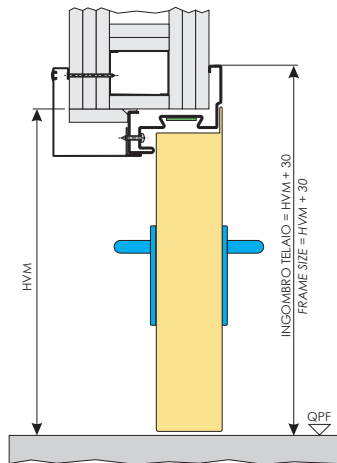
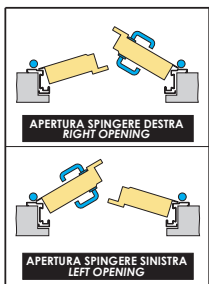
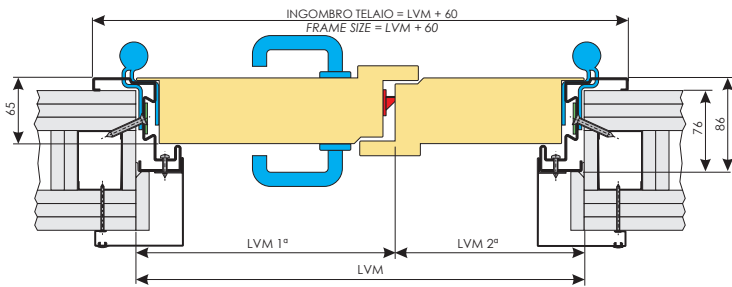

I disegni sono esemplificativi e fuori scala
Dierre si riserva il cambiamento della presente senza preavviso
Le quote sono espresse in millimetri

Drawing are examples and not in scale
Dierre holds the right to change this without notice
Dimensions are expressed in millimetres

L'imbotte non è necessario con la marcatura CE
The padding is not necessary with the CE marking

* Per la compatibilità con i vari extra consultare il listino prezzi
For compatibility with the various extras refer to the price list

FINITURE FINISHINGS	
LACCATA RAL PER ESTERNI EXTERIOR RAL LACQUER	SI / YES
IN ACCIAIO INOX STAINLESS STEEL	NO
IN ACCIAIO PRERIVESTITO PRE-COATED STEEL	SI / YES
TIPOLOGIE DI MONTAGGIO MOUNTING SOLUTIONS	
SU PARETI IN CARTONGESSO ON PLASTERBOARD WALLS	

**CARATTERISTICHE PRESTAZIONALI STANDARD
STANDARD PERFORMANCE FEATURES**

TRASMITTANZA TERMICA THERMAL TRANSMITTANCE		2,2 W/m²K
ABBATTIMENTO ACUSTICO NOISE REDUCTION		N.D.
DI SERIE STANDARD		
MANIGLIA + MANIGLIA CON SERRATURA ANTINCENDIO HANDLE + HANDLE WITH FIRE RESISTANT LOCK		
CERNIERE A VISTA EXPOSED HINGES		
PESO WEIGHT		40 kg/m²

**CARATTERISTICHE PRESTAZIONALI SUPPLEMENTARI
OPTIONAL PERFORMANCE FEATURES**

KIT FUMI FREDDI (S _c) COLD FUMES KIT (S _c) KIT FUMI CALDI (S _m /S ₂₀₀) HOT FUMES KIT (S _m /S ₂₀₀)		SI / YES
ABBATTIMENTO ACUSTICO con soglia mobile NOISE REDUCTION with mobile threshold		29 dB
ABBATTIMENTO ACUSTICO con soglia fissa (uscita NON CONFORME alle uscite d'emergenza) NOISE REDUCTION with fixed threshold (this exit is NOT COMPLIANT with emergency exit requirements)		35 dB
PERMEABILITÀ ALL'ARIA E RESISTENZA AL CARICO DEL VENTO PERMEABILITY TO AIR AND RESISTANCE TO THE WIND LOAD		classe 4 C4
PORTA PER ESTERNI EN 14351-1 * Abbinare sempre almeno la guarnizione di battuta EXTERNAL DOOR EN 14351-1 * Always match at least the door stop seal		SI / YES

**VARIANTI SUPPLEMENTARI
ADDITIONAL VARIATIONS**

FINISTRATURA RETTANGOLARE/OBLÒ (vedi limiti a pagina 22) SQUARE WINDOW / ROUND WINDOW (see limits on page 22)		SI / YES
SOPRALUCE/FIANCOLUCE FANLIGHT/SIDELIGHT		NO
ZOCCOLO/FASCIA PARACOLPI BUMPER SKIRTING/BAND		SI / YES
CERNIERE A 3 ALI 3-FLAP HINGES		SI / YES
MANIGLIERIA ANTIPANICO PANIC EXIT BAR		SI / YES
SERRATURA A 3 PUNTI DI CHIUSURA 3 LOCK POINTS LOCK		SI / YES
MANIGLIERIA CONFORME ALLE NORME DIN DIN COMPLIANT HANDLES		SI / YES

**CONTROLLO ACCESSI
ACCESS MONITORING**

SBLOCCO ELETTRICO ELECTRIC UNLOCK		SI / YES
ELETTROMANIGLIA ELECTROHANDLE		SI / YES
SERRATURA ELETTRICA ELECTRIC LOCK		SI / YES
ELETTROMAGNETI ELECTROMAGNETS		SI / YES
ELETTROBLOCCHI MAGNETICI MAGNETIC ELECTRIC BLOCKS		SI / YES

**DIMENSIONI CERTIFICATE (Per la disponibilità nella propria nazione, chiedere al ns ufficio tecnico)
CERTIFIED DIMENSIONS (Ask our technical assistance office for availability in your country)**

LARGHEZZA (LVM) WIDTH (LVM)	1150 ÷ 2300 (575 + 575) ÷ (1150 + 1150)
ALTEZZA (HVM) HEIGHT (HVM)	1987 ÷ 2650

CARATTERISTICHE PRESTAZIONALI STANDARD
STANDARD PERFORMANCE FEATURES

TRASMITTANZA TERMICA
 THERMAL TRANSMITTANCE



N.D.

ABBATTIMENTO ACUSTICO
 NOISE REDUCTION



N.D.

DI SERIE STANDARD

MANIGLIA + MANIGLIA CON SERRATURA ANTINCENDIO
 HANDLE + HANDLE WITH FIRE RESISTANT LOCK



CERNIERE A VISTA
 EXPOSED HINGES



PESO
 WEIGHT

30 kg/m²

CARATTERISTICHE PRESTAZIONALI SUPPLEMENTARI
OPTIONAL PERFORMANCE FEATURES

KIT FUMI FREDDI (S_e)
 COLD FUMES KIT (S_e)
 KIT FUMI CALDI (S_m/S₂₀₀)
 HOT FUMES KIT (S_m/S₂₀₀)



NO

ABBATTIMENTO ACUSTICO con soglia mobile
 NOISE REDUCTION with mobile threshold



NO

ABBATTIMENTO ACUSTICO con soglia fissa
 (uscita NON CONFORME alle uscite d'emergenza)

NOISE REDUCTION with fixed threshold
 (this exit is NOT COMPLIANT with emergency exit requirements)



NO

PERMEABILITÀ ALL'ARIA E RESISTENZA AL CARICO DEL VENTO
 PERMEABILITY TO AIR AND RESISTANCE TO THE WIND LOAD



NO

PORTA PER ESTERNI EN 14351-1 *
 Abbinare sempre almeno la guarnizione di battuta
 EXTERNAL DOOR EN 14351-1 *
 Always match at least the door stop seal



SI / YES

VARIANTI SUPPLEMENTARI
ADDITIONAL VARIATIONS

FINISTRATURA RETTANGOLARE/OBLÒ
 (vedi limiti a pagina 22)
 SQUARE WINDOW / ROUND WINDOW
 (see limits on page 22)



SI / YES

SOPRALUCE/FIANCOLUCE
 FANLIGHT/SIDELIGHT



NO

ZOCCOLO/FASCIA PARACOLPI
 BUMPER SKIRTING/BAND



SI / YES

CERNIERE A 3 ALI
 3-FLAP HINGES



SI / YES

MANIGLIERA ANTIPANICO
 PANIC EXIT BAR



SI / YES

SERRATURA A 3 PUNTI DI CHIUSURA
 3 LOCK POINTS LOCK



SI / YES

MANIGLIERA CONFORME ALLE NORME DIN
 DIN COMPLIANT HANDLES

NO

CONTROLLO ACCESSI
ACCESS MONITORING

SBLOCCO ELETTRICO
 ELECTRIC UNLOCK

SI / YES

ELETTROMANIGLIA
 ELECTROHANDLE

SI / YES

SERRATURA ELETTRICA
 ELECTRIC LOCK

SI / YES

ELETTROMAGNETI
 ELECTROMAGNETS

SI / YES

ELETTROBLOCCHI MAGNETICI
 MAGNETIC ELECTRIC BLOCKS

SI / YES

DIMENSIONI CERTIFICATE (Per la disponibilità nella propria nazione, chiedere al ns ufficio tecnico)
CERTIFIED DIMENSIONS (Ask our technical assistance office for availability in your country)

LARGHEZZA (LVM)
 WIDTH (LVM)

500 ÷ 1350

ALTEZZA (HVM)
 HEIGHT (HVM)

1750 ÷ 2645

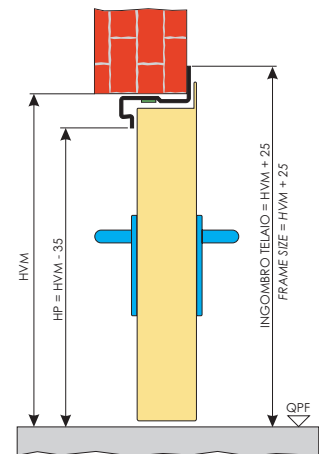
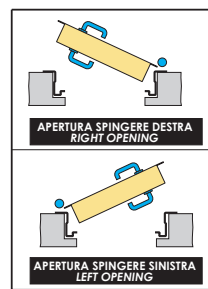
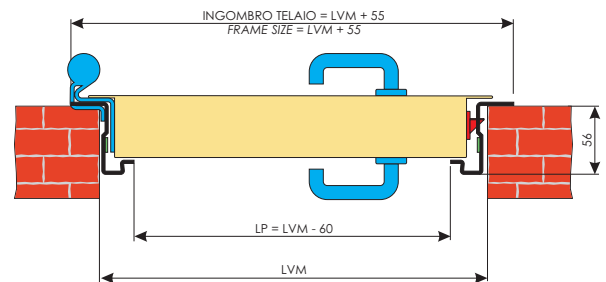

I disegni sono esemplificativi e fuori scala
 Dierre si riserva il cambiamento della presente senza preavviso
 Le quote sono espresse in millimetri

Drawing are examples and not in scale
 Dierre holds the right to change this without notice
 Dimensions are expressed in millimetres

* Per la compatibilità con i vari extra consultare il listino prezzi
 For compatibility with the various extras refer to the price list

FINITURE
FINISHINGS

LACCATA RAL PER ESTERNI
 EXTERIOR RAL LACQUER

SI / YES

IN ACCIAIO INOX
 STAINLESS STEEL

NO

IN ACCIAIO PRERIVESTITO
 PRE-COATED STEEL

SI / YES

TIPOLOGIE DI MONTAGGIO
MOUNTING SOLUTIONS

CON ZANCHE
 WITH TIES



SU CONTROTELAIO
 ON SUB-FRAME



CON TASSELLI
 WITH BOLTS



SU MAZZETTA
 ON REVEAL



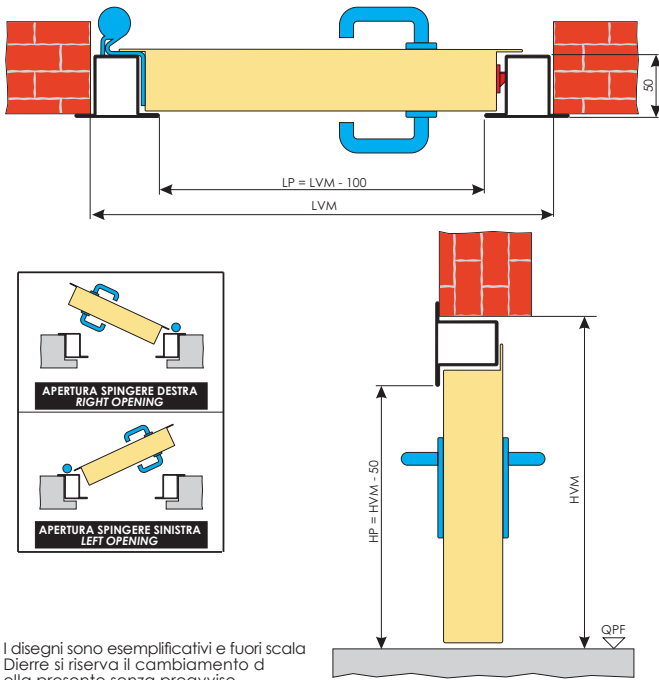

I disegni sono esemplificativi e fuori scala
 Dierre si riserva il cambiamento d
 ella presente senza preavviso
 Le quote sono espresse in millimetri

Drawing are examples and not in scale
 Dierre holds the right to change this without notice
 Dimensions are expressed in millimetres

* Per la compatibilità con i vari extra consultare il listino prezzi
 For compatibility with the various extras refer to the price list

FINITURE FINISHINGS	
LACCATA RAL PER ESTERNI EXTERIOR RAL LACQUER	SI / YES
IN ACCIAIO INOX STAINLESS STEEL	NO
IN ACCIAIO PRERIVESTITO PRE-COATED STEEL	SI / YES
TIPOLOGIE DI MONTAGGIO MOUNTING SOLUTIONS	
CON ZANCHE WITH TIES	
CON TASSELLI WITH BOLTS	
TIPOLOGIE DI TELAIO TYPES OF FRAME	
A "Z" "Z" SHAPE	
A "T" "T" SHAPE	
A "L" "L" SHAPE	

CARATTERISTICHE PRESTAZIONALI STANDARD STANDARD PERFORMANCE FEATURES	
TRASMITTANZA TERMICA THERMAL TRANSMITTANCE	N.D.
ABBATTIMENTO ACUSTICO NOISE REDUCTION	N.D.
DI SERIE STANDARD	
MANIGLIA + MANIGLIA CON SERRATURA ANTINCENDIO HANDLE + HANDLE WITH FIRE RESISTANT LOCK	
CERNIERE A VISTA EXPOSED HINGES	
PESO WEIGHT	30 kg/m ²
CARATTERISTICHE PRESTAZIONALI SUPPLEMENTARI OPTIONAL PERFORMANCE FEATURES	
KIT FUMI FREDDI (S _d) COLD FUMES KIT (S _d)	NO
KIT FUMI CALDI (S _m /S ₂₀₀) HOT FUMES KIT (S _m /S ₂₀₀)	NO
ABBATTIMENTO ACUSTICO con soglia mobile NOISE REDUCTION with mobile threshold	NO
ABBATTIMENTO ACUSTICO con soglia fissa (uscita NON CONFORME alle uscite d'emergenza) NOISE REDUCTION with fixed threshold (this exit is NOT COMPLIANT with emergency exit requirements)	NO
PERMEABILITÀ ALL'ARIA E RESISTENZA AL CARICO DEL VENTO PERMEABILITY TO AIR AND RESISTANCE TO THE WIND LOAD	NO
PORTA PER ESTERNI EN 14351-1 * Abbinare sempre almeno la guarnizione di battuta EXTERNAL DOOR EN 14351-1 * Always match at least the door stop seal	SI / YES
VARIANTI SUPPLEMENTARI ADDITIONAL VARIATIONS	
FINISTRATURA RETTANGOLARE/OBLÒ (vedi limiti a pagina 22) SQUARE WINDOW / ROUND WINDOW (see limits on page 22)	SI / YES
SOPRALUCE/FIANCOLUCE FANLIGHT/SIDELIGHT	NO
ZOCCOLO/FASCIA PARACOLPI BUMPER SKIRTING/BAND	SI / YES
CERNIERE A 3 ALI 3-FLAP HINGES	NO
MANIGLIERIA ANTIPANICO PANIC EXIT BAR	SI / YES
SERRATURA A 3 PUNTI DI CHIUSURA 3 LOCK POINTS LOCK	SI / YES
MANIGLIERIA CONFORME ALLE NORME DIN DIN COMPLIANT HANDLES	NO
CONTROLLO ACCESSI ACCESS MONITORING	
SBLOCCO ELETTRICO ELECTRIC UNLOCK	SI / YES
ELETTROMANIGLIA ELECTROHANDLE	SI / YES
SERRATURA ELETTRICA ELECTRIC LOCK	SI / YES
ELETTROMAGNETI ELECTROMAGNETS	SI / YES
ELETTROBLOCCHI MAGNETICI MAGNETIC ELECTRIC BLOCKS	SI / YES
DIMENSIONI CERTIFICATE (Per la disponibilità nella propria nazione, chiedere al ns ufficio tecnico) CERTIFIED DIMENSIONS (Ask our technical assistance office for availability in your country)	
LARGHEZZA (LVM) WIDTH (LVM)	520 ÷ 1140
ALTEZZA (HVM) HEIGHT (HVM)	1730 ÷ 2640

CARATTERISTICHE PRESTAZIONALI STANDARD
STANDARD PERFORMANCE FEATURES

TRASMITTANZA TERMICA
THERMAL TRANSMITTANCE



1,8 W/m²K

ABBATTIMENTO ACUSTICO con soglia mobile
NOISE REDUCTION with mobile threshold



38 dB

DI SERIE STANDARD

MANIGLIA + MANIGLIA CON SERRATURA ANTINCENDIO
HANDLE + HANDLE WITH FIRE RESISTANT LOCK



CERNIERE A VISTA
EXPOSED HINGES



PESO
WEIGHT

55 kg/m²

CARATTERISTICHE PRESTAZIONALI SUPPLEMENTARI
OPTIONAL PERFORMANCE FEATURES

KIT FUMI FREDDI (S_d)
COLD FUMES KIT (S_d)
KIT FUMI CALDI (S_m/S₂₀₀)
HOT FUMES KIT (S_m/S₂₀₀)



NO

PERMEABILITÀ ALL'ARIA E RESISTENZA AL CARICO DEL VENTO
PERMEABILITY TO AIR AND RESISTANCE TO THE WIND LOAD



NO

PORTA PER ESTERNI EN 14351-1 *
EXTERNAL DOOR EN 14351-1 *



SI / YES

VARIANTI SUPPLEMENTARI
ADDITIONAL VARIATIONS

FINISTRATURA RETTANGOLARE/OBLÒ
(vedi limiti a pagina 22)
SQUARE WINDOW / ROUND WINDOW
(see limits on page 22)



NO

SOPRALUCE/FIANCOLUCE
FANLIGHT/SIDELIGHT



NO

ZOCCOLO/FASCIA PARACOLPI
BUMPER SKIRTING/BAND



SI / YES

CERNIERE A 3 ALI
3-FLAP HINGES



SI / YES

MANIGLIERIA ANTIPANICO
PANIC EXIT BAR



SI / YES

SERRATURA A 3 PUNTI DI CHIUSURA
3 LOCK POINTS LOCK



SI / YES

MANIGLIERIA CONFORME ALLE NORME DIN
DIN COMPLIANT HANDLES



SI / YES

CONTROLLO ACCESSI
ACCESS MONITORING

SBLOCCO ELETTRICO
ELECTRIC UNLOCK

SI / YES

ELETTROMANIGLIA
ELECTROHANDLE

SI / YES

SERRATURA ELETTRICA
ELECTRIC LOCK

SI / YES

ELETTROMAGNETI
ELECTROMAGNETS

SI / YES

ELETTROBLOCCHI MAGNETICI
MAGNETIC ELECTRIC BLOCKS

SI / YES

DIMENSIONI CERTIFICATE (Per la disponibilità nella propria nazione, chiedere al ns ufficio tecnico)
CERTIFIED DIMENSIONS (Ask our technical assistance office for availability in your country)

LARGHEZZA (LVM)
WIDTH (LVM)

750 ÷ 1350

ALTEZZA (HVM)
HEIGHT (HVM)

2000 ÷ 2650

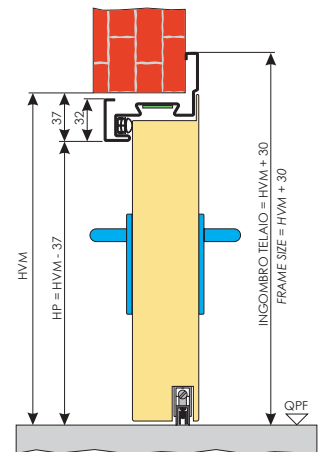
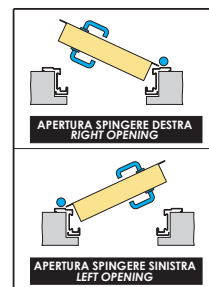
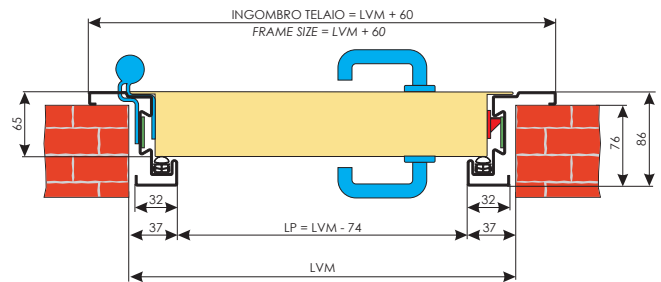

I disegni sono esemplificativi e fuori scala
Dierre si riserva il cambiamento della presente senza preavviso
Le quote sono espresse in millimetri

Drawing are examples and not in scale
Dierre holds the right to change this without notice
Dimensions are expressed in millimetres

* Per la compatibilità con i vari extra consultare il listino prezzi
For compatibility with the various extras refer to the price list

FINITURE
FINISHINGS

LACCATA RAL PER ESTERNI
EXTERIOR RAL LACQUER

SI / YES

IN ACCIAIO INOX
STAINLESS STEEL

SI / YES

IN ACCIAIO PRERIVESTITO
PRE-COATED STEEL

SI / YES

TIPOLOGIE DI MONTAGGIO
MOUNTING SOLUTIONS

CON ZANCHE
WITH TIES



SU CONTROTELAIO
ON SUB-FRAME



CON TASSELLI
WITH BOLTS



SU MAZZETTA
ON REVEAL



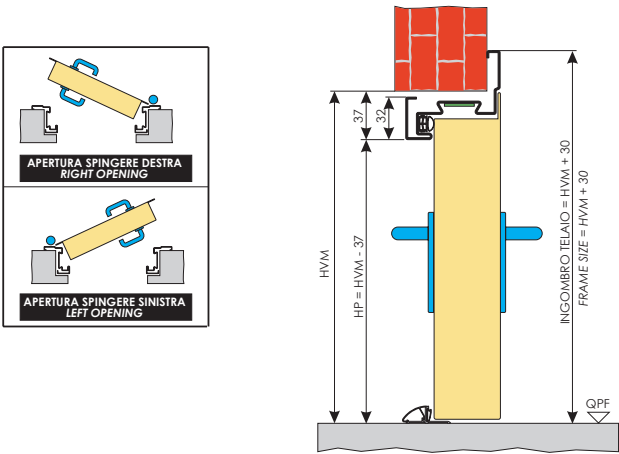
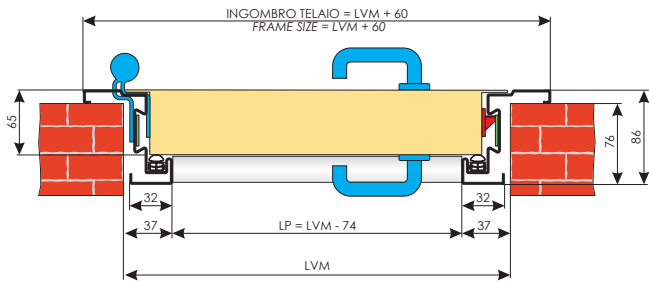

I disegni sono esemplificativi e fuori scala
 Dierre si riserva il cambiamento della presente senza preavviso
 Le quote sono espresse in millimetri

Drawing are examples and not in scale
 Dierre holds the right to change this without notice
 Dimensions are expressed in millimetres

* Per la compatibilità con i vari extra consultare il listino prezzi
 For compatibility with the various extras refer to the price list

FINITURE FINISHINGS	
LACCATA RAL PER ESTERNI EXTERIOR RAL LACQUER	SI / YES
IN ACCIAIO INOX STAINLESS STEEL	SI / YES
IN ACCIAIO PRERIVESTITO PRE-COATED STEEL	SI / YES
TIPOLOGIE DI MONTAGGIO MOUNTING SOLUTIONS	
CON ZANCHE WITH TIES	
SU CONTROTELAIO ON SUB-FRAME	
CON TASSELLI WITH BOLTS	
SU MAZZETTA ON REVEAL	

**CARATTERISTICHE PRESTAZIONALI STANDARD
 STANDARD PERFORMANCE FEATURES**

TRASMITTANZA TERMICA THERMAL TRANSMITTANCE		1,8 W/m ² K
ABBATTIMENTO ACUSTICO con soglia fissa (uscita NON CONFORME alle uscite d'emergenza) NOISE REDUCTION with fixed threshold (this exit is NOT COMPLIANT with emergency exit requirements)		42 dB

**DI SERIE
 STANDARD**

MANIGLIA + MANIGLIA CON SERRATURA ANTINCENDIO HANDLE + HANDLE WITH FIRE RESISTANT LOCK	
CERNIERE A VISTA EXPOSED HINGES	
PESO WEIGHT	55 kg/m ²

**CARATTERISTICHE PRESTAZIONALI SUPPLEMENTARI
 OPTIONAL PERFORMANCE FEATURES**

KIT FUMI FREDDI (S ₂) COLD FUMES KIT (S ₂)		NO
KIT FUMI CALDI (S _m /S ₂₀₀) HOT FUMES KIT (S _m /S ₂₀₀)		NO
PERMEABILITÀ ALL'ARIA E RESISTENZA AL CARICO DEL VENTO PERMEABILITY TO AIR AND RESISTANCE TO THE WIND LOAD		NO
PORTA PER ESTERNI EN 14351-1 * EXTERNAL DOOR EN 14351-1 *		SI / YES

**VARIANTI SUPPLEMENTARI
 ADDITIONAL VARIATIONS**

FINISTRATURA RETTANGOLARE/OBLÒ (vedi limiti a pagina 22) SQUARE WINDOW / ROUND WINDOW (see limits on page 22)		NO
SOPRALUCE/FIANCOLUCE FANLIGHT/SIDE LIGHT		NO
ZOCCOLO/FASCIA PARACOLPI BUMPER SKIRTING/BAND		SI / YES
CERNIERE A 3 ALI 3-FLAP HINGES		SI / YES
MANIGLIERIA ANTIPANICO PANIC EXIT BAR		SI / YES
SERRATURA A 3 PUNTI DI CHIUSURA 3 LOCK POINTS LOCK		SI / YES
MANIGLIERIA CONFORME ALLE NORME DIN DIN COMPLIANT HANDLES		SI / YES

**CONTROLLO ACCESSI
 ACCESS MONITORING**

SBLOCCO ELETTRICO ELECTRIC UNLOCK	SI / YES
ELETTROMANIGLIA ELECTROHANDLE	SI / YES
SERRATURA ELETTRICA ELECTRIC LOCK	SI / YES
ELETTROMAGNETI ELECTROMAGNETS	SI / YES
ELETTROBLOCCHI MAGNETICI MAGNETIC ELECTRIC BLOCKS	SI / YES

**DIMENSIONI CERTIFICATE (Per la disponibilità nella propria nazione, chiedere al rs ufficio tecnico)
 CERTIFIED DIMENSIONS (Ask our technical assistance office for availability in your country)**

LARGHEZZA (LVM) WIDTH (LVM)	750 ÷ 1350
ALTEZZA (HVM) HEIGHT (HVM)	2000 ÷ 2650

CARATTERISTICHE PRESTAZIONALI STANDARD
STANDARD PERFORMANCE FEATURES

TRASMITTANZA TERMICA
 THERMAL TRANSMITTANCE  1,8 W/m² K

ANTIEFFRAZIONE
 BURGLAR RESISTANCE  classe 2

DI SERIE
STANDARD

MANIGLIA + MANIGLIA CON SERRATURA ANTINCENDIO
 HANDLE + HANDLE WITH FIRE RESISTANT LOCK 

CERNIERE A VISTA
 EXPOSED HINGES 

SERRATURA A 3 PUNTI DI CHIUSURA
 3 LOCK POINTS LOCK 

PESO
 WEIGHT 40 kg/m²

CARATTERISTICHE PRESTAZIONALI SUPPLEMENTARI
OPTIONAL PERFORMANCE FEATURES

KIT FUMI FREDDI (S_d)
 COLD FUMES KIT (S_d)  SI / YES
 KIT FUMI CALDI (S_m/S₂₀₀)
 HOT FUMES KIT (S_m/S₂₀₀)

PERMEABILITÀ ALL'ARIA E RESISTENZA AL CARICO DEL VENTO
 PERMEABILITY TO AIR AND RESISTANCE TO THE WIND LOAD  NO

PORTA PER ESTERNI EN 14351-1 *
 Abbinare sempre almeno la guarnizione di battuta
 EXTERNAL DOOR EN 14351-1 *
 Always match at least the door stop seal  SI / YES

VARIANTI SUPPLEMENTARI
ADDITIONAL VARIATIONS

FINISTRATURA RETTANGOLARE/OBLÒ
 (vedi limiti a pagina 22)
 SQUARE WINDOW / ROUND WINDOW
 (see limits on page 22)  NO

SOPRALUCE/FIANCOLUCE
 FANLIGHT/SIDLIGHT  NO

ZOCCOLO/FASCIA PARACOLPI
 BUMPER SKIRTING/BAND  SI / YES

CERNIERE A 3 ALI
 3-FLAP HINGES  NO

MANIGLIERIA ANTIPANICO
 PANIC EXIT BAR  SI / YES

SERRATURA A 3 PUNTI DI CHIUSURA
 3 LOCK POINTS LOCK  SI / YES

MANIGLIERIA CONFORME ALLE NORME DIN
 DIN COMPLIANT HANDLES SI / YES

CONTROLLO ACCESSI
ACCESS MONITORING

SBLOCCO ELETTRICO
 ELECTRIC UNLOCK NO

ELETTROMANIGLIA
 ELECTROHANDLE NO

SERRATURA ELETTRICA
 ELECTRIC LOCK NO

ELETTROMAGNETI
 ELECTROMAGNETS SI / YES

ELETTROBLOCCHI MAGNETICI
 MAGNETIC ELECTRIC BLOCKS SI / YES

DIMENSIONI CERTIFICATE (Per la disponibilità nella propria nazione, chiedere al ns ufficio tecnico)
CERTIFIED DIMENSIONS (Ask our technical assistance office for availability in your country)

LARGHEZZA (LVM)
 WIDTH (LVM) 800 ÷ 1100

ALTEZZA (HVM)
 HEIGHT (HVM) 1987 ÷ 2365

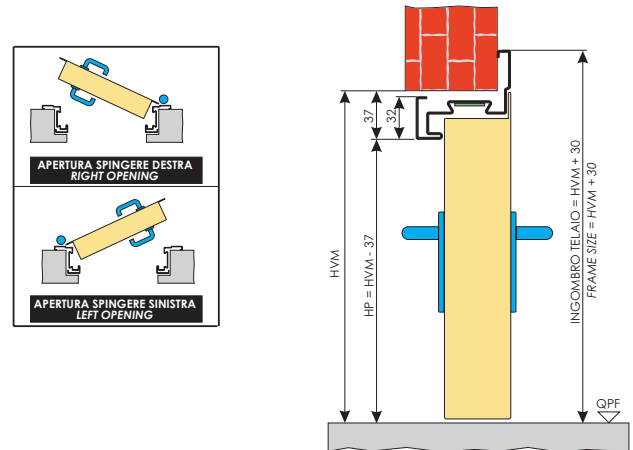
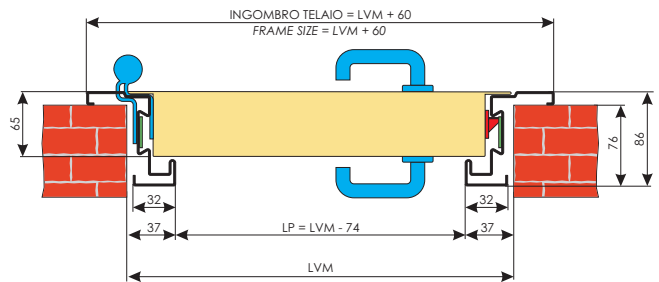

I disegni sono esemplificativi e fuori scala
 Dierre si riserva il cambiamento della presente senza preavviso
 Le quote sono espresse in millimetri

Drawing are examples and not in scale
 Dierre holds the right to change this without notice
 Dimensions are expressed in millimetres

* Per la compatibilità con i vari extra consultare il listino prezzi
 For compatibility with the various extras refer to the price list

FINITURE
FINISHINGS

LACCATA RAL PER ESTERNI
 EXTERIOR RAL LACQUER SI / YES

IN ACCIAIO INOX
 STAINLESS STEEL NO

IN ACCIAIO PRERIVESTITO
 PRE-COATED STEEL SI / YES

TIPOLOGIE DI MONTAGGIO
MOUNTING SOLUTIONS

CON ZANCHE
 WITH TIES 

SU CONTROTELAIO
 ON SUB-FRAME 

CON TASSELLI
 WITH BOLTS 

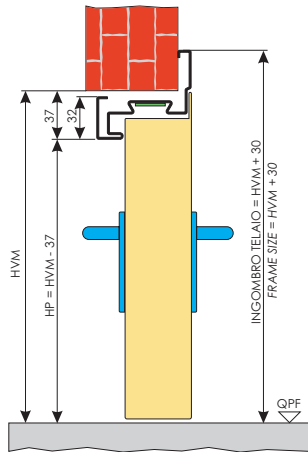
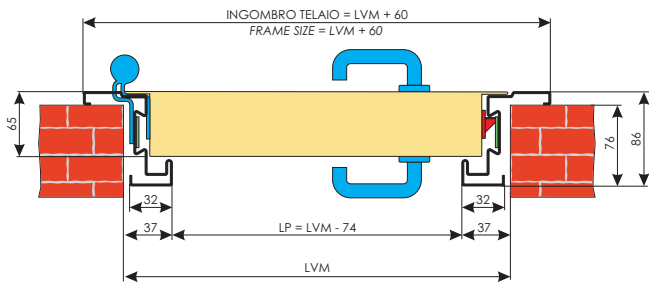

I disegni sono esemplificativi e fuori scala
 Dierre si riserva il cambiamento della presente senza preavviso
 Le quote sono espresse in millimetri

Drawing are examples and not in scale
 Dierre holds the right to change this without notice
 Dimensions are expressed in millimetres

* Per la compatibilità con i vari extra consultare il listino prezzi
 For compatibility with the various extras refer to the price list

FINITURE FINISHINGS	
LACCATA RAL PER ESTERNI EXTERIOR RAL LACQUER	SI / YES
IN ACCIAIO INOX STAINLESS STEEL	NO
IN ACCIAIO PRERIVESTITO PRE-COATED STEEL	SI / YES
TIPOLOGIE DI MONTAGGIO MOUNTING SOLUTIONS	
CON ZANCHE WITH TIES	
SU CONTROTELAIO ON SUB-FRAME	
CON TASSELLI WITH BOLTS	

CARATTERISTICHE PRESTAZIONALI STANDARD STANDARD PERFORMANCE FEATURES	
TRASMITTANZA TERMICA THERMAL TRANSMITTANCE	1,8 W/m ² K
ANTIEFFRAZIONE BURGLAR RESISTANCE	classe 3
DI SERIE STANDARD	
MANIGLIA + MANIGLIA CON DEFENDER ANTIPANICO HANDLE + HANDLE WITH ANTIPANIC DEFENDER	
CERNIERE A VISTA EXPOSED HINGES	
SERRATURA A 3 PUNTI DI CHIUSURA 3 LOCK POINTS LOCK	
PESO WEIGHT	55 kg/m ²
CARATTERISTICHE PRESTAZIONALI SUPPLEMENTARI OPTIONAL PERFORMANCE FEATURES	
KIT FUMI FREDDI (S _a) COLD FUMES KIT (S _a) KIT FUMI CALDI (S _m /S ₂₀₀) HOT FUMES KIT (S _m /S ₂₀₀)	SI / YES
PERMEABILITÀ ALL'ARIA E RESISTENZA AL CARICO DEL VENTO PERMEABILITY TO AIR AND RESISTANCE TO THE WIND LOAD	NO
PORTA PER ESTERNI EN 14351-1 * Abbinare sempre almeno la guarnizione di battuta EXTERNAL DOOR EN 14351-1 * Always match at least the door stop seal	SI / YES
VARIANTI SUPPLEMENTARI ADDITIONAL VARIATIONS	
FINISTRATURA RETTANGOLARE/OBLÒ (vedi limiti a pagina 22) SQUARE WINDOW / ROUND WINDOW (see limits on page 22)	NO
SOPRALUCE/FIANCOLUCE FANLIGHT/SIDE LIGHT	NO
ZOCCOLO/FASCIA PARACOLPI BUMPER SKIRTING/BAND	SI / YES
CERNIERE A 3 ALI 3-FLAP HINGES	NO
MANIGLIERIA ANTIPANICO PANIC EXIT BAR	SI / YES
SERRATURA A 3 PUNTI DI CHIUSURA 3 LOCK POINTS LOCK	NO
MANIGLIERIA CONFORME ALLE NORME DIN DIN COMPLIANT HANDLES	SI / YES
CONTROLLO ACCESSI ACCESS MONITORING	
SBLOCCO ELETTRICO ELECTRIC UNLOCK	NO
ELETTROMANIGLIA ELECTROHANDLE	NO
SERRATURA ELETTRICA ELECTRIC LOCK	NO
ELETTROMAGNETI ELECTROMAGNETS	SI / YES
ELETTROBLOCCHI MAGNETICI MAGNETIC ELECTRIC BLOCKS	SI / YES
DIMENSIONI CERTIFICATE CERTIFIED DIMENSIONS (Per la disponibilità nella propria nazione, chiedere al rs ufficio tecnico) (Ask our technical assistance office for availability in your country)	
LARGHEZZA (LVM) WIDTH (LVM)	800 ÷ 1100
ALTEZZA (HVM) HEIGHT (HVM)	1987 ÷ 2365

CARATTERISTICHE PRESTAZIONALI STANDARD
STANDARD PERFORMANCE FEATURES

TRASMITTANZA TERMICA
 THERMAL TRANSMITTANCE



1,8 W/m²K

ABBATTIMENTO ACUSTICO
 NOISE REDUCTION



19 dB

DI SERIE STANDARD

MANIGLIA + MANIGLIA CON SERRATURA ANTINCENDIO
 HANDLE + HANDLE WITH FIRE RESISTANT LOCK



CERNIERE A 3 ALI
 3-FLAP HINGES



PESO
 WEIGHT

35 kg/m²

CARATTERISTICHE PRESTAZIONALI SUPPLEMENTARI
OPTIONAL PERFORMANCE FEATURES

KIT FUMI FREDDI (S_e)
 COLD FUMES KIT (S_e)
 KIT FUMI CALDI (S_m/S₂₀₀)
 HOT FUMES KIT (S_m/S₂₀₀)



SI / YES

ABBATTIMENTO ACUSTICO con soglia mobile
 NOISE REDUCTION with mobile threshold



27 dB

ABBATTIMENTO ACUSTICO con soglia fissa
 (uscita NON CONFORME alle uscite d'emergenza)



34 dB

NOISE REDUCTION with fixed threshold
 (this exit is NOT COMPLIANT with emergency exit requirements)

PERMEABILITÀ ALL'ARIA E RESISTENZA AL CARICO DEL VENTO
 PERMEABILITY TO AIR AND RESISTANCE TO THE WIND LOAD



classe 4
 C4

PORTA PER ESTERNI EN 14351-1 *
 Abbinare sempre almeno la guarnizione di battuta
 EXTERNAL DOOR EN 14351-1 *
 Always match at least the door stop seal



SI / YES

VARIANTI SUPPLEMENTARI
ADDITIONAL VARIATIONS

FINISTRATURA RETTANGOLARE/OBLÒ
 (vedi limiti a pagina 22)
 SQUARE WINDOW / ROUND WINDOW
 (see limits on page 22)



SI / YES

SOPRALUCE/FIANCOLUCE
 FANLIGHT/SIDELIGHT



NO

ZOCCOLO/FASCIA PARACOLPI
 BUMPER SKIRTING/BAND



SI / YES

CERNIERE A 3 ALI
 3-FLAP HINGES



NO

MANIGLIERA ANTIPANICO
 PANIC EXIT BAR



SI / YES

SERRATURA A 3 PUNTI DI CHIUSURA
 3 LOCK POINTS LOCK



SI / YES

MANIGLIERA CONFORME ALLE NORME DIN
 DIN COMPLIANT HANDLES

SI / YES

CONTROLLO ACCESSI
ACCESS MONITORING

SBLOCCO ELETTRICO
 ELECTRIC UNLOCK

SI / YES

ELETTROMANIGLIA
 ELECTROHANDLE

SI / YES

SERRATURA ELETTRICA
 ELECTRIC LOCK

SI / YES

ELETTROMAGNETI
 ELECTROMAGNETS

SI / YES

ELETTROBLOCCHI MAGNETICI
 MAGNETIC ELECTRIC BLOCKS

SI / YES

DIMENSIONI CERTIFICATE (Per la disponibilità nella propria nazione, chiedere al ns ufficio tecnico)
CERTIFIED DIMENSIONS (Ask our technical assistance office for availability in your country)

LARGHEZZA (LVM)
 WIDTH (LVM)

675 ÷ 1350

ALTEZZA (HVM)
 HEIGHT (HVM)

1987 ÷ 2650

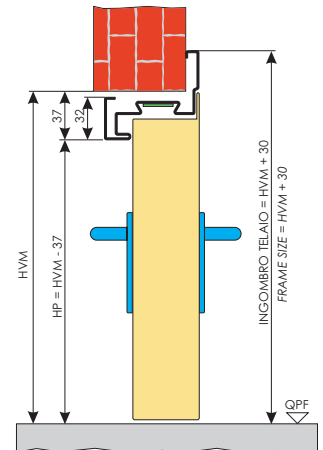
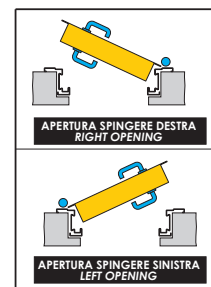
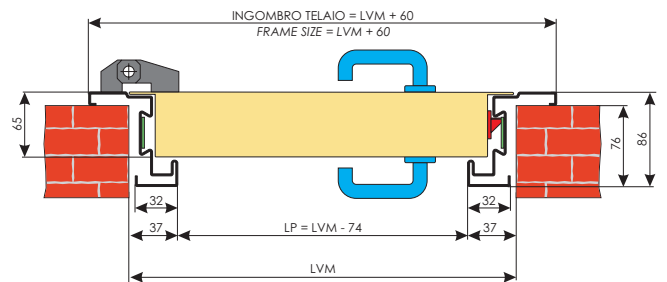

I disegni sono esemplificativi e fuori scala
 Dierre si riserva il cambiamento della presente senza preavviso
 Le quote sono espresse in millimetri

Drawing are examples and not in scale
 Dierre holds the right to change this without notice
 Dimensions are expressed in millimetres

* Per la compatibilità con i vari extra consultare il listino prezzi
 For compatibility with the various extras refer to the price list

FINITURE
FINISHINGS

LACCATA RAL PER ESTERNI
 EXTERIOR RAL LACQUER

SI / YES

IN ACCIAIO INOX
 STAINLESS STEEL

NO

IN ACCIAIO PRERIVESTITO
 PRE-COATED STEEL

SI / YES

TIPOLOGIE DI MONTAGGIO
MOUNTING SOLUTIONS

CON ZANCHE
 WITH TIES



SU CONTROTELAIO
 ON SUB-FRAME



CON TASSELLI
 WITH BOLTS



SU MAZZETTA
 ON REVEAL



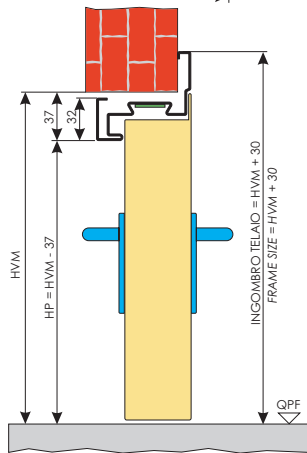
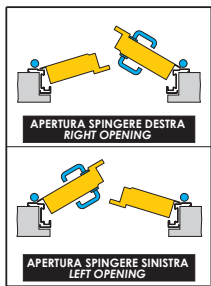
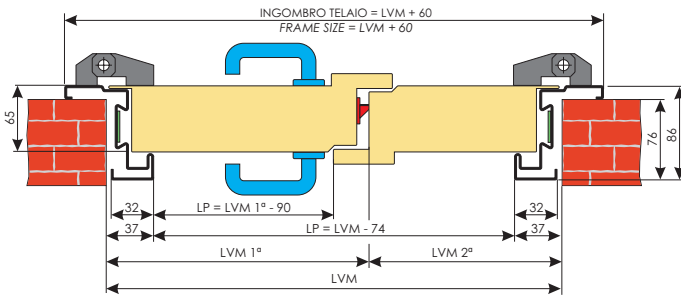

I disegni sono esemplificativi e fuori scala
 Dierre si riserva il cambiamento della presente senza preavviso
 Le quote sono espresse in millimetri

Drawing are examples and not in scale
 Dierre holds the right to change this without notice
 Dimensions are expressed in millimetres

* Per la compatibilità con i vari extra consultare il listino prezzi
 For compatibility with the various extras refer to the price list

FINITURE FINISHINGS

LACCATA RAL PER ESTERNI EXTERIOR RAL LACQUER	SI / YES
IN ACCIAIO INOX STAINLESS STEEL	NO
IN ACCIAIO PRERIVESTITO PRE-COATED STEEL	SI / YES

TIPOLOGIE DI MONTAGGIO MOUNTING SOLUTIONS

CON ZANCHE WITH TIES	
SU CONTROTELAIO ON SUB-FRAME	
CON TASSELLI WITH BOLTS	
SU MAZZETTA ON REVEAL	

CARATTERISTICHE PRESTAZIONALI STANDARD STANDARD PERFORMANCE FEATURES

TRASMITTANZA TERMICA THERMAL TRANSMITTANCE		2,2 W/m²K
ABBATTIMENTO ACUSTICO NOISE REDUCTION		19 dB
DI SERIE STANDARD		
MANIGLIA + MANIGLIA CON SERRATURA ANTINCENDIO HANDLE + HANDLE WITH FIRE RESISTANT LOCK		
CERNIERE A 3 ALI 3-FLAP HINGE		
PESO WEIGHT		35 kg/m²

CARATTERISTICHE PRESTAZIONALI SUPPLEMENTARI OPTIONAL PERFORMANCE FEATURES

KIT FUMI FREDDI (S _d) COLD FUMES KIT (S _d) KIT FUMI CALDI (S _m /S ₂₀₀) HOT FUMES KIT (S _m /S ₂₀₀)		SI / YES
ABBATTIMENTO ACUSTICO con soglia mobile NOISE REDUCTION with mobile threshold		25 dB
ABBATTIMENTO ACUSTICO con soglia fissa (uscita NON CONFORME alle uscite d'emergenza) NOISE REDUCTION with fixed threshold (this exit is NOT COMPLIANT with emergency exit requirements)		30 dB
PERMEABILITÀ ALL'ARIA E RESISTENZA AL CARICO DEL VENTO PERMEABILITY TO AIR AND RESISTANCE TO THE WIND LOAD		classe 4 C4
PORTA PER ESTERNI EN 14351-1 * Abbinare sempre almeno la guarnizione di battuta EXTERNAL DOOR EN 14351-1 * Always match at least the door stop seal		SI / YES

VARIANTI SUPPLEMENTARI ADDITIONAL VARIATIONS

FINISTRATURA RETTANGOLARE/OBLÒ (vedi limiti a pagina 22) SQUARE WINDOW / ROUND WINDOW (see limits on page 22)		SI / YES
SOPRALUCE/FIANCOLUCE FANLIGHT/SIDELIGHT		SI / YES
ZOCCOLO/FASCIA PARACOLPI BUMPER SKIRTING/BAND		SI / YES
CERNIERE A 3 ALI 3-FLAP HINGES		NO
MANIGLIERIA ANTIPANICO PANIC EXIT BAR		SI / YES
SERRATURA A 3 PUNTI DI CHIUSURA 3 LOCK POINTS LOCK		SI / YES
MANIGLIERIA CONFORME ALLE NORME DIN DIN COMPLIANT HANDLES		SI / YES

CONTROLLO ACCESSI ACCESS MONITORING

SBLOCCO ELETTRICO ELECTRIC UNLOCK		SI / YES
ELETTROMANIGLIA ELECTROHANDLE		SI / YES
SERRATURA ELETTRICA ELECTRIC LOCK		SI / YES
ELETTROMAGNETI ELECTROMAGNETS		SI / YES
ELETTROBLOCCHI MAGNETICI MAGNETIC ELECTRIC BLOCKS		SI / YES

DIMENSIONI CERTIFICATE (Per la disponibilità nella propria nazione, chiedere al ns ufficio tecnico) CERTIFIED DIMENSIONS (Ask our technical assistance office for availability in your country)

LARGHEZZA (LVM) WIDTH (LVM)	950 ÷ 2600 (600 + 350) ÷ (1300 + 1300)
ALTEZZA (HVM) HEIGHT (HVM)	1987 ÷ 2650

CARATTERISTICHE PRESTAZIONALI STANDARD
STANDARD PERFORMANCE FEATURES

TRASMITTANZA TERMICA THERMAL TRANSMITTANCE		1,8 W/m²K
ABBATTIMENTO ACUSTICO NOISE REDUCTION		19 dB
DI SERIE STANDARD		
MANIGLIA + MANIGLIA CON SERRATURA ANTINCENDIO HANDLE + HANDLE WITH FIRE RESISTANT LOCK		
CERNIERE NASCOSTE CONCEALED HINGES		
PESO WEIGHT		40 kg/m²

CARATTERISTICHE PRESTAZIONALI SUPPLEMENTARI
OPTIONAL PERFORMANCE FEATURES

KIT FUMI FREDDI (S _d) COLD FUMES KIT (S _d) KIT FUMI CALDI (S _m /S ₂₀₀) HOT FUMES KIT (S _m /S ₂₀₀)		NO
ABBATTIMENTO ACUSTICO con soglia mobile NOISE REDUCTION with mobile threshold		27 dB
ABBATTIMENTO ACUSTICO con soglia fissa (uscita NON CONFORME alle uscite d'emergenza) NOISE REDUCTION with fixed threshold (this exit is NOT COMPLIANT with emergency exit requirements)		34 dB
PERMEABILITÀ ALL'ARIA E RESISTENZA AL CARICO DEL VENTO PERMEABILITY TO AIR AND RESISTANCE TO THE WIND LOAD		classe 4 C4
PORTA PER ESTERNI EN 14351-1 * Abbinare sempre almeno la guarnizione di battuta EXTERNAL DOOR EN 14351-1 * Always match at least the door stop seal		SI / YES

VARIANTI SUPPLEMENTARI
ADDITIONAL VARIATIONS

FINESTRATURA RETTANGOLARE/OBLÒ (vedi limiti a pagina 22) SQUARE WINDOW / ROUND WINDOW (see limits on page 22)		SI / YES
SOPRALUCE/FIANCOLUCE FANLIGHT/SIDELIGHT		NO
ZOCCOLO/FASCIA PARACOLPI BUMPER SKIRTING/BAND		SI / YES
CERNIERE A 3 ALI 3-FLAP HINGES		NO
MANIGLIERA ANTIPANICO PANIC EXIT BAR		SI / YES
SERRATURA A 3 PUNTI DI CHIUSURA 3 LOCK POINTS LOCK		SI / YES
MANIGLIERA CONFORME ALLE NORME DIN DIN COMPLIANT HANDLES		SI / YES

CONTROLLO ACCESSI
ACCESS MONITORING

SBLOCCO ELETTRICO ELECTRIC UNLOCK		SI / YES
ELETTROMANIGLIA ELECTROHANDLE		SI / YES
SERRATURA ELETTRICA ELECTRIC LOCK		SI / YES
ELETTROMAGNETI ELECTROMAGNETS		SI / YES
ELETTROBLOCCHI MAGNETICI MAGNETIC ELECTRIC BLOCKS		SI / YES

DIMENSIONI CERTIFICATE (Per la disponibilità nella propria nazione, chiedere al ns ufficio tecnico)
CERTIFIED DIMENSIONS (Ask our technical assistance office for availability in your country)

LARGHEZZA (LVM) WIDTH (LVM)		675 ÷ 1350
ALTEZZA (HVM) HEIGHT (HVM)		1987 ÷ 2300

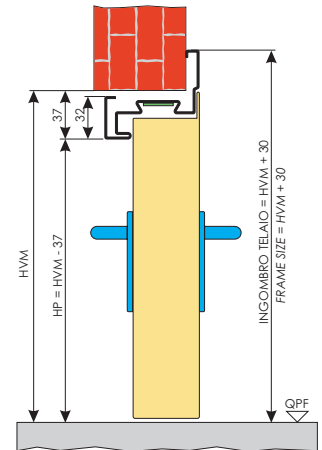
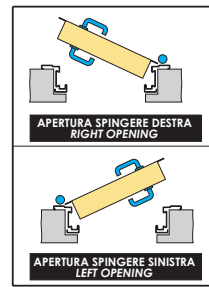
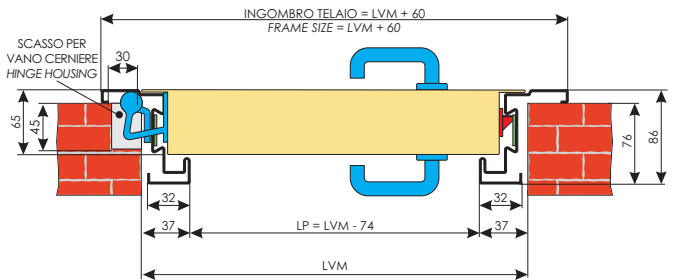

I disegni sono esemplificativi e fuori scala
 Dierre si riserva il cambiamento della presente senza preavviso
 Le quote sono espresse in millimetri

Drawing are examples and not in scale
 Dierre holds the right to change this without notice
 Dimensions are expressed in millimetres

* Per la compatibilità con i vari extra consultare il listino prezzi
 For compatibility with the various extras refer to the price list

FINITURE
FINISHINGS



































LACCATA RAL PER ESTERNI EXTERIOR RAL LACQUER	SI / YES
IN ACCIAIO INOX STAINLESS STEEL	NO
IN ACCIAIO PRERIVESTITO PRE-COATED STEEL	NO

TIPOLOGIE DI MONTAGGIO
MOUNTING SOLUTIONS

CON ZANCHE WITH TIES	
SU CONTROTELAIO ON SUB-FRAME	
CON TASSELLI WITH BOLTS	
SU MAZZETTA ON REVEAL	

TAVOLA SINOTTICA
SYNOPTIC TABLE

* PER LA DISPONIBILITÀ NELLA
 PROPRIA NAZIONE, CHIEDERE AL
 NOSTRO UFFICIO TECNICO
 ASK OUR TECHNICAL ASSISTANCE
 OFFICE FOR AVAILABILITY IN YOUR
 COUNTRY

	NEW IDRA 1B El, 60 (N05) Pag 28	NEW IDRA 1B El, 60 (N70) Pag 30	NEW IDRA 2B El, 60 (N15) Pag 29	NEW IDRA 2B El, 60 (N71) Pag 31	NEW IDRA 1B El, 120 (N01) Pag 32	NEW IDRA 1B El, 120 (N02) Pag 34	NEW IDRA 2B El, 120 (N10) Pag 33	NEW IDRA 2B El, 120 (N14) Pag 35
PORTA STANDARD STANDARD DOOR								
RESISTENZA AL FUOCO FIRE RESISTANCE		El, 60	El, 60	El, 60	El, 60	El, 120	El, 120	El, 120
TRASMITTANZA TERMICA THERMAL TRANSMITTANCE		W=1,8 W/m²K	W=1,8 W/m²K	W=2,2 W/m²K	W=2,2 W/m²K	W=1,8 W/m²K	W=1,8 W/m²K	W=2,2 W/m²K
ABBATTIMENTO ACUSTICO NOISE REDUCTION		19 dB	19 dB	19 dB	19 dB	19 dB	19 dB	/
ANTIEFFRAZIONE BURGLAR RESISTANCE		○	○	○	○	○	○	○
EXTRA SUPPLEMENTARI EXTRAS								
KIT FUMI FREDDI (S _c) COLD FUMES KIT (S _c) KIT FUMI CALDI (S _m /S _{acc}) HOT FUMES KIT (S _m /S _{acc})		●	●	●	●	●	●	●
ABBATTIMENTO ACUSTICO (dB) NOISE REDUCTION (dB)		27 - 34	27 - 34	25 - 30	25 - 30	29 - 35	29 - 35	32 - 36
TENUTA ARIA/VENTO AIR/WIND TIGHTNESS		●	●	●	●	●	●	●
FRANCOLUCE/SOPRALUCE SIDE LIGHT/FANLIGHT		●	○	●	○	●	○	○
PORTA PER ESTERNI EN 14351-1 EXTERNAL DOOR EN 14351-1		●	●	●	●	●	●	●
MONTAGGIO FITTING								
CON ZANCHE WITH TIES		●	○	●	○	●	○	○
SU CONTROTELAIO ON SUB-FRAME		●	○	●	○	●	○	○
CON TASSELLI WITH BOLTS		●	○	●	○	●	○	○
SU MAZZETTA ON REVEAL		●	○	●	○	●	○	○
SU PARETI IN CARTONGESSO ON PLASTERBOARD WALLS		○	●	○	●	○	●	●
FINITURA FINISHING								
FINITURE RAL PER ESTERNI RAL FINISHING FOR EXTERIOR		●	●	●	●	●	●	●
IN ACCIAIO INOX STAINLESS STEEL		●	●	●	●	●	○	○
IN ACCIAIO PRERIVESTITO PRE-COATED STEEL		●	●	●	●	●	●	●
ACCESSORI STANDARD STANDARD ACCESSORIES								
MANIGLIA+MANIGLIA ANTIFORTUNISTICA IN RESINA NERA HANDLE+HANDLE ACCIDENT PREVENTION BLACK EPOXY		●	●	●	●	●	●	●
MANIGLIA+MANIGLIA CON DEFENDER HANDLE+HANDLE WITH DEFENDER		○	○	○	○	○	○	○
SERRATURA A 1 PUNTO DI CHIUSURA 1-LOCKING POINT LOCK		●	●	●	●	●	●	●
SERRATURA A 3 PUNTI DI CHIUSURA 3-LOCKING POINT LOCK		○	○	○	○	○	○	○
CERNIERA A VISTA EXPOSED HINGE		●	●	●	●	●	●	●
CERNIERA NASCOSTA CONCEALED HINGE		○	○	○	○	○	○	○
CERNIERA A 3 ALI 3-FLAP HINGE		○	○	○	○	○	○	○
EXTRA SUPPLEMENTARI ADDITIONAL EXTRAS								
FINESTRAURA RETTANGOLARE OBLO RECTANGULAR WINDOW ROUND WINDOW		●	●	●	●	●	●	●
FASCIA/ZOCCOLO PARACOLIPI BUMPER BAND/SKIRTING		●	●	●	●	●	●	●
CERNIERA A 3 ALI 3-FLAP HINGE		●	●	●	●	●	●	●
MANIGLIERIA ANTIPANICO PANIC EXIT BAR		●	●	●	●	●	●	●
SERRATURA A 3 PUNTI DI CHIUSURA 3-LOCKING POINT LOCK		●	●	●	●	●	●	●
MANIGLIERIA CONFORME ALLE NORME DIN DIN COMPLIANT HANDLES		●	●	●	●	●	●	●
CONTROLLO ACCESSI ACCESS MONITORING								
SBLOCCO ELETTRICO ELECTRIC UNLOCK		●	●	●	●	●	●	●
ELETTROMANIGLIA ELECTROHANDLE		●	●	●	●	●	●	●
SERRATURA ELETTRICA ELECTRIC LOCK		●	●	●	●	●	●	●
ELETTROMAGNETI ELECTROMAGNETS		●	●	●	●	●	●	●
ELETTROBLOCCHI MAGNETICI MAGNETIC ELECTRIC BLOCKS		●	●	●	●	●	●	●
DIMENSIONI CERTIFICATE* CERTIFIED DIMENSIONS								
LARGHEZZA (LVM) WIDTH (LVM)	675 1350	675 1350	950 2600	1150 2300	675 1350	675 1350	950 2600	1150 2300
ALTEZZA (HVM) HEIGHT (HVM)	1987 2650	1987 2650	1987 2650	1987 2650	1987 2650	1987 2650	1987 2650	1987 2650

● DISPONIBILE - AVAILABLE

○ NON DISPONIBILE - NOT AVAILABLE

IDRA 1B E ₁ 30 (T38) Pag 36	IDRA 1B E ₁ 30 (T39) Pag 37	NEW IDRA 1B FIREWALL E ₁ 90 (NA7) Pag 44	NEW IDRA 1B E ₁ 60 SILENT (N47) Pag 38	NEW IDRA 1B E ₁ 60 SILENT (N48) Pag 39	NEW IDRA 1B SECURITY E ₁ 120 (ND1)Pag 40	NEW IDRA 1B SECURITY E ₁ 60 (ND5) Pag 41	NEW IDRA 1B PREMIUM E ₁ 60 (N60) Pag 42	NEW IDRA 2B PREMIUM E ₁ 60 (N61) Pag 43
E ₁ 30	E ₁ 30	E ₁ 90	E ₁ 60	E ₁ 60	E ₁ 120	E ₁ 60	E ₁ 60	E ₁ 60
W=1,8 W/m²K	W=1,8 W/m²K	W=1,8 W/m²K	W=1,8 W/m²K	W=1,8 W/m²K	W=1,8 W/m²K	W=1,8 W/m²K	W=1,8 W/m²K	W=2,2 W/m²K
/	/	19 dB	38 dB	42 dB	19 dB	19 dB	19 dB	19 dB
○	○	○	○	○	Classe 2	Classe 3	○	○
○	○	○	○	○	●	●	●	●
○	○	27 - 34	/	/	/	/	27 - 34	25 - 30
○	○	●	○	○	/	/	●	●
○	○	○	○	○	○	○	○	○
●	●	●	●	●	●	●	●	●
●	●	●	●	●	●	○	●	●
●	○	●	●	●	●	○	●	●
●	●	●	●	●	●	○	●	●
●	○	●	●	●	●	○	●	●
○	○	○	○	○	○	●	○	○
●	●	●	●	●	●	●	●	●
○	○	○	●	●	○	○	●	●
●	●	○	●	●	●	●	●	●
●	●	●	●	●	●	○	●	●
○	○	○	○	○	○	●	○	○
●	●	●	●	●	○	○	●	●
○	○	○	○	○	●	●	○	○
●	●	○	●	●	●	●	○	○
○	○	●	○	○	○	○	○	○
○	○	○	○	○	○	○	●	●
●	●	●	○	○	○	○	●	●
●	●	●	●	●	●	●	●	●
○	○	○	●	●	○	○	○	○
●	●	●	●	●	●	●	●	●
○	○	●	●	●	○	○	●	●
○	○	○	○	○	○	○	○	○
●	●	●	●	●	○	○	●	●
●	●	●	●	●	○	○	●	●
●	●	●	●	●	○	○	●	●
●	●	●	●	●	●	●	●	●
●	●	●	●	●	●	●	●	●

● DISPONIBILE - AVAILABLE
○ NON DISPONIBILE - NOT AVAILABLE



REFERENZE

Permedica Spa - Merate (LC)

1-2

CampZero Active Luxury Resort - Champoluc (AO)

3-4-5-6

THE ITALIAN STYLE DOOR



DIERRE S.p.A. - Strada Statale per Chieri, 66/15
14019 Villanova d'Asti (AT)
Tel.39/0141.94.94.11 - Fax 39/0141.94.64.27
E-mail: info@dierre.it - www.dierre.com